

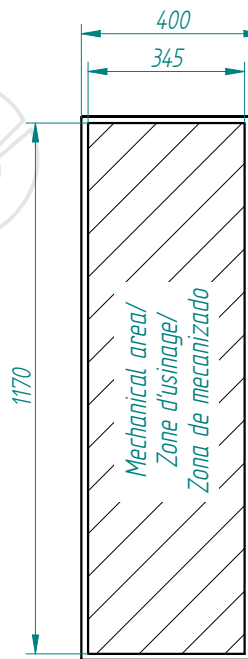

This present document and its contents are confidential and are the exclusive intellectual and / or industrial property of DELVALLE. In addition to any technology, design, invention, work, process, know-how, calculation, manual, method, solution, idea, improvement, drawing, diagram, modification, combination and, in short, any associated information involving industrial or intellectual property developed or supplied by DELVALLE on the occasion of the quote, order execution or incorporated into the design or operation of the supply. The recipient may not use such property in his favour or in that of a third party for purposes other than the fulfilment of the order and the operation and maintenance of the supply, without the prior written consent of DELVALLE. It is strictly forbidden to totally or partially reproduce this document and to misuse it and / or to show it to third parties. The infringing parties shall be required to pay the corresponding compensation for damages and any other legal or criminal responsibility. The infringement may give rise to.

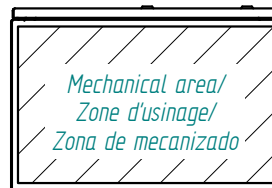
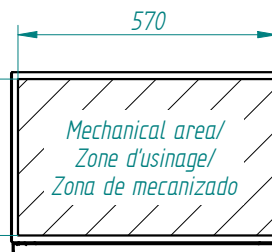
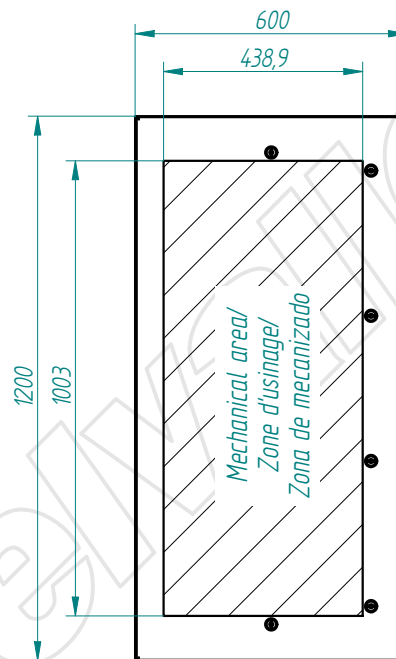
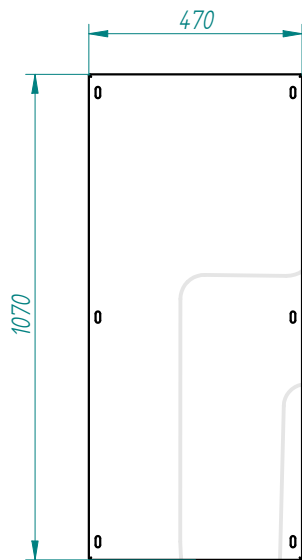
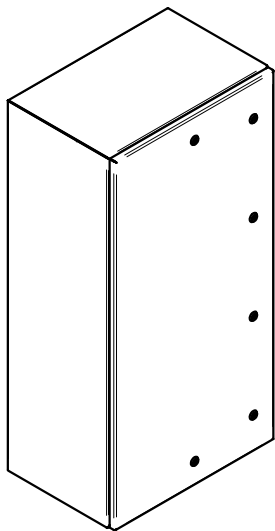
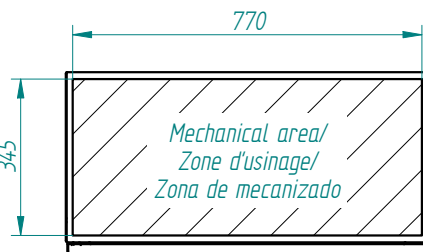
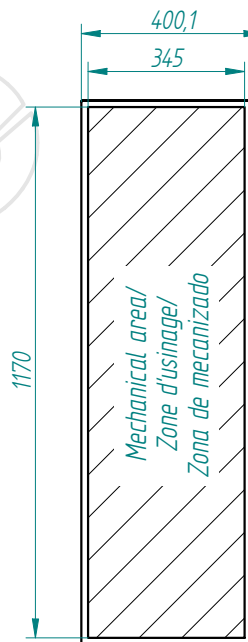
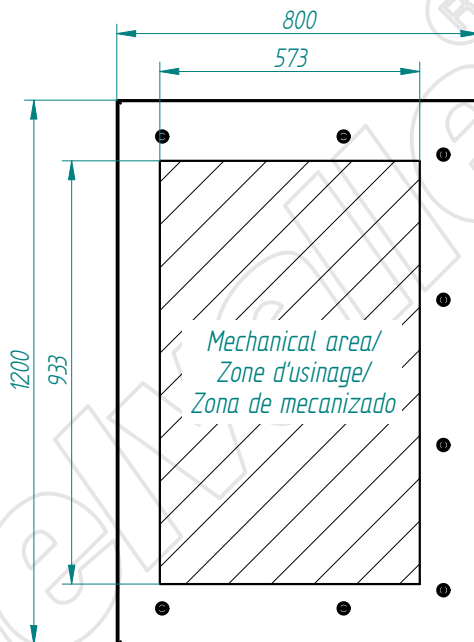
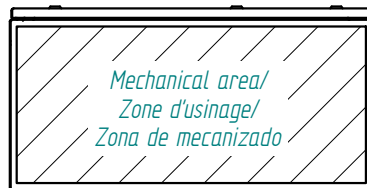
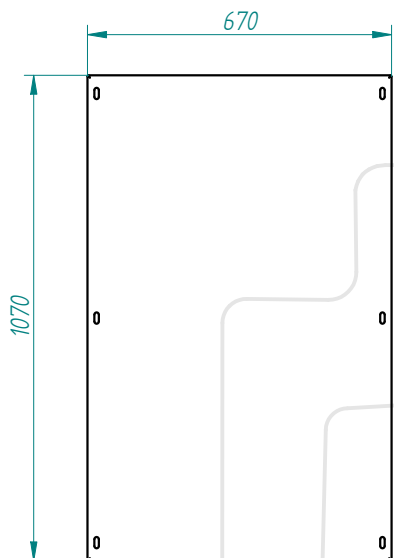
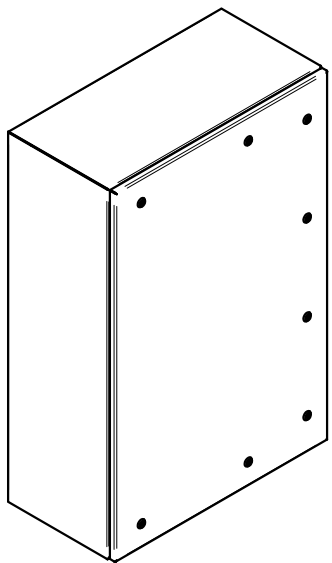

TOLERANCIA GENERAL DE MECANIZACION según DIN 7168					Referencia:		FECHA:	FIRMA:	
						DIBUJADO:	28/03/2022	D.Martínez	
						APROBADO:	28/03/2022	D.Martínez	
	Creación del documento	28/03/2022	D.MTNEZ	A	-	DESIGNACIÓN:		Nº PLANO:	
	MODIFICACIONES	FECHA:	FIRMA:	REVISIÓN:	plegado: acabado:	tribex-1200x600x400-estandar			

This present document and its contents are confidential, and are the exclusive intellectual and/or industrial property of DELVALLE. In addition to any technology, design, invention, work, process, know-how, calculation, manual, method, solution, idea, improvement, drawing, diagram, modification, contribution and, in short, any associated information or documentation involving industrial or intellectual property developed or supplied by DELVALLE on the occasion of the quote, order execution or incorporated into the design or operation of the supply. The recipient may not use such property in his favour or in that of a third party for purposes other than the fulfilment of the order and the operation and maintenance of the supply, without the prior written consent of DELVALLE. It is strictly forbidden to totally or partially reproduce this document and to misuse it and/or to show it to third parties. The infringing parties shall be required to pay the corresponding compensation for damages, and any other legal or criminal responsibility if the infringement may give rise to.



TOLERANCIA GENERAL DE MECANIZACION segun DIN 7168					Referencia:		FECHA:	FIRMA:	
						DIBUJADO:	28/07/2015	D.Martinez	
							APROBADO:	28/07/2015	D.Martinez
	Creación del documento	28/07/2015	D.MTNEZ	A	-	DESIGNACIÓN:			Nº PLANO:
	MODIFICACIONES	FECHA:	FIRMA:	REVISIÓN:	plegado: acabado:	tribex-1200x800x400-estandar			



This present document and its contents are confidential, and are the exclusive intellectual and / or industrial property of DELVALLE, in addition to any technology, design, invention, work, process, know-how, calculation, manual, method, solution, drawing, improvement, diagram, modification, contribution and, in short, any associated information or documentation involving industrial or intellectual property developed or supplied by DELVALLE on the occasion of the quote, order execution or incorporated into the design or operation of the supply. The recipient may not use such property in his favour or in that of a third party for purposes other than the fulfilment of the order and the operation and maintenance of the supply, without the prior written consent of DELVALLE. It is strictly forbidden to totally or partially reproduce this document and to misuse it and / or to show it to third parties. The infringing parties shall be required to pay the corresponding compensation for damages, and any other legal or criminal responsibility if the infringement may give rise to.

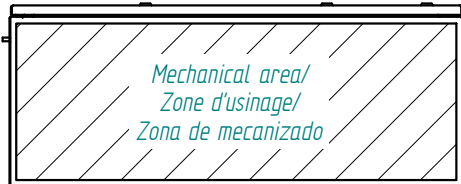
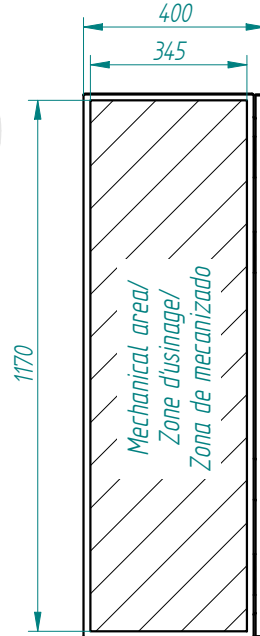
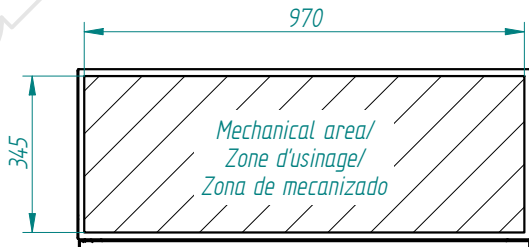
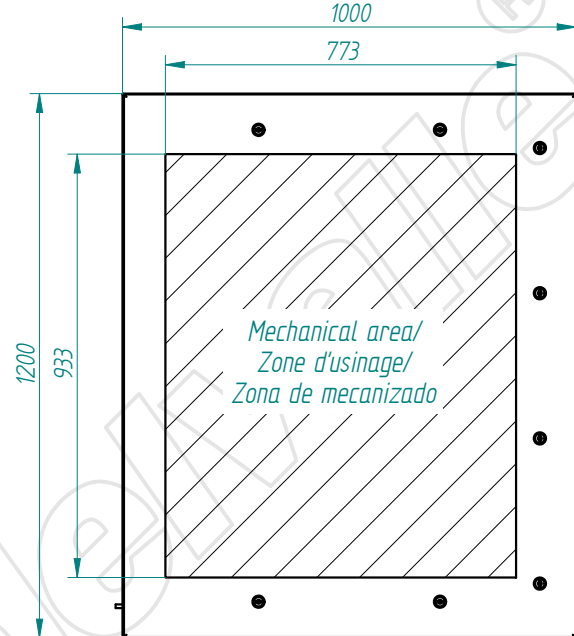
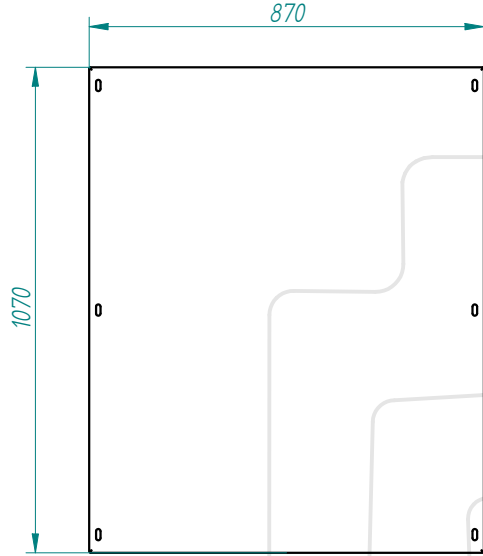
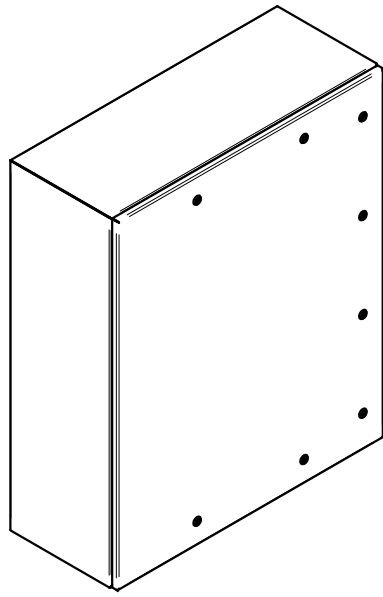

TOLERANCIA GENERAL DE MECANIZACION segun DIN 7168	Creación del documento	28/07/2015	D.MTNEZ	A	Referencia: - plegado: - acabado:	DIBUJADO:	FECHA:	FIRMA:	
	MODIFICACIONES	FECHA:	FIRMA:	REVISIÓN:		APROBADO:	28/07/2015	D.Martinez	
DESIGNACIÓN:						tribex-1200x1000x400-estandar			Nº PLANO:



This present document and its contents are confidential, and are the exclusive intellectual and / or industrial property of DELVALLE. In addition to any technology, design, invention, work, process, know-how, calculation, manual, method, solution, idea, improvement, drawing, diagram, modification, contribution and, in short, any associated information involving industrial or intellectual property developed or supplied by DELVALLE on the occasion of the quote, order execution or incorporated into the design or operation of the supply. The recipient may not use such property in his favour or in that of a third party for purposes other than the fulfilment of the order and the operation and maintenance of the supply, without the prior written consent of DELVALLE. It is strictly forbidden to totally or partially reproduce this document and to misuse it and / or to show it to third parties. The infringing parties shall be required to pay the corresponding compensation for damages, and any other legal or criminal responsibility. The infringement may give rise to.

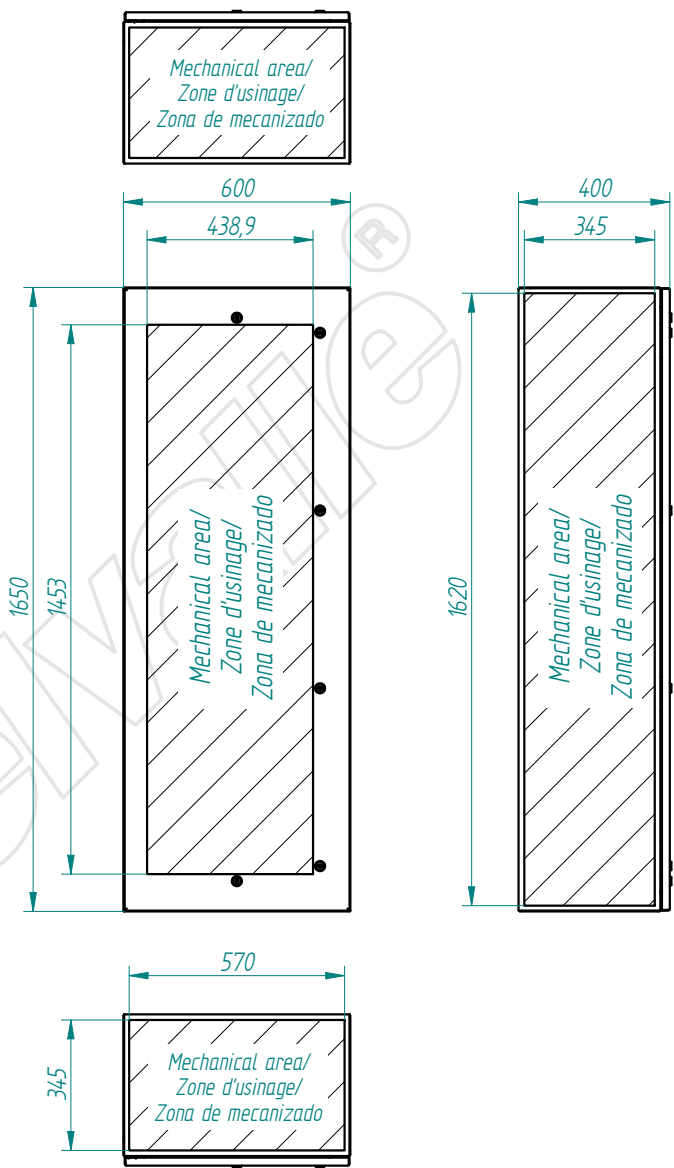
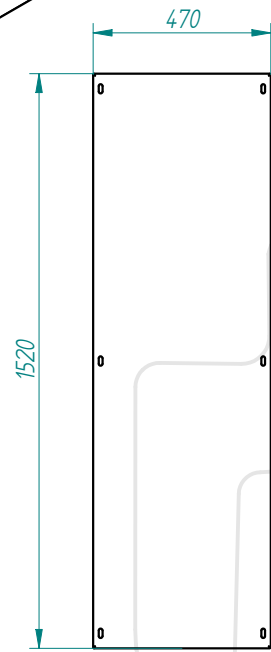
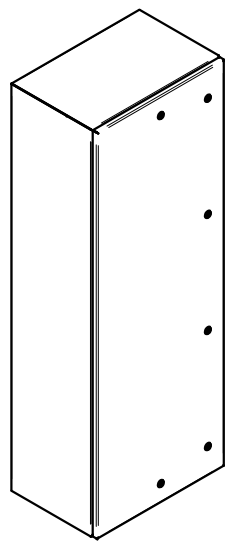

TOLERANCIA GENERAL DE MECANIZACION según DIN 7168					Referencia:
	Creación del documento	28/03/2022	D.MTNEZ	A	-
	MODIFICACIONES	FECHA:	FIRMA:	REVISIÓN:	plegado: acabado:

DIBUJADO:	FECHA:	FIRMA:
28/03/2022	28/03/2022	D.Martínez
APROBADO:		D.Martínez
DESIGNACIÓN:		
tribex-1650x600x400-estandar		

Nº PLANO:



This present document and its contents are confidential, and are the exclusive intellectual and / or industrial property of DELVALLE ., in addition to any technology, design, invention, work, process, know-how, calculation, manual, method, solution, idea, improvement, drawing, diagram, modification, contribution and, in short, any associated information involving industrial or intellectual property developed or supplied by DELVALLE on the occasion of the quote, order execution or incorporated into the design or operation of the supply. The recipient may not use such property in his favour or in that of a third party for purposes other than the fulfilment of the order and the operation and maintenance of the supply, without the prior written consent of DELVALLE. It is strictly forbidden to totally or partially reproduce this document and to misuse it and / or to show it to third parties. The infringing parties shall be required to pay the corresponding compensation for damages, and any other legal or criminal responsibility if the infringement may give rise to.

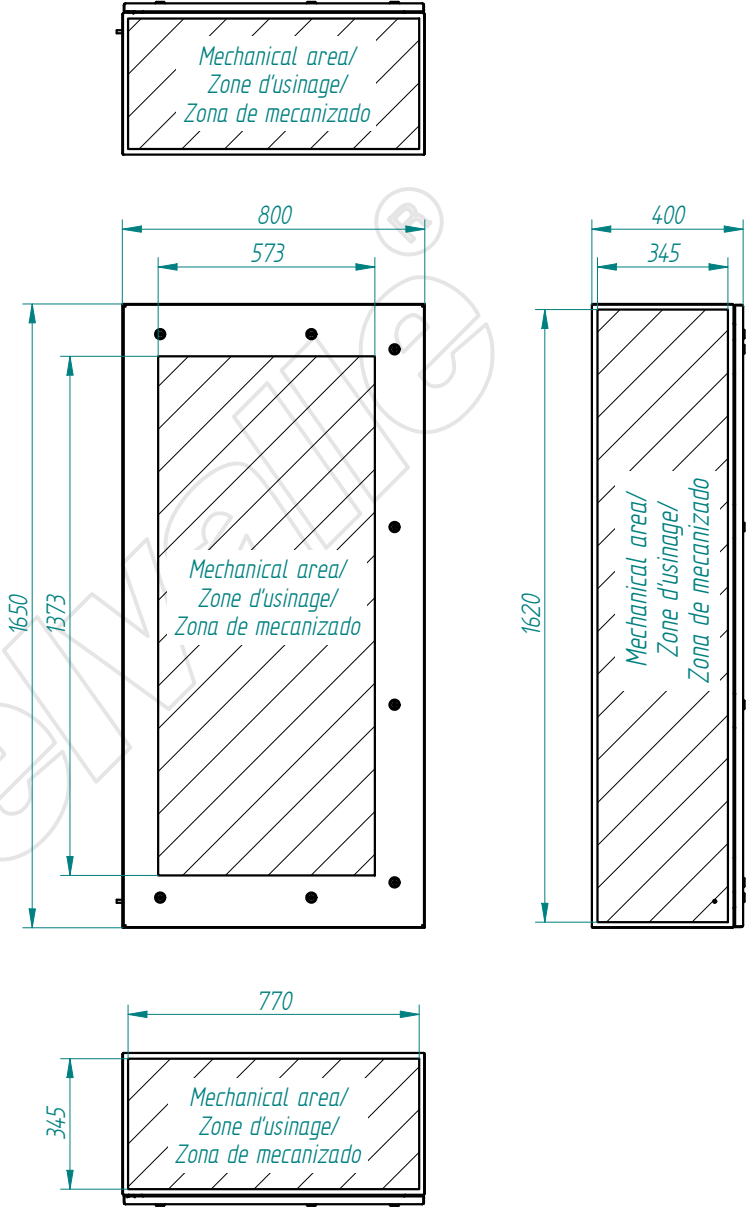
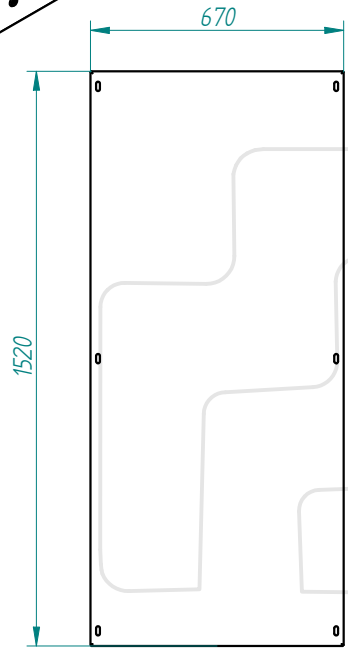
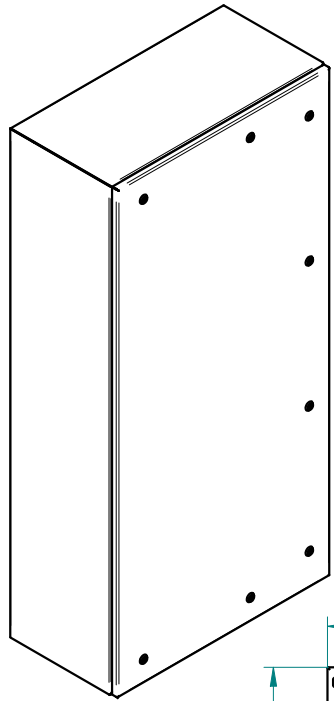

TOLERANCIA GENERAL DE MECANIZACION segun DIN 7168	Creación del documento	28/07/2015	D.MTNEZ	A	Referencia: - plegado: - acabado:	DIBUJADO:	28/07/2015	FIRMA:	D.Martinez	 Nº PLANO:
	MODIFICACIONES	FECHA:	FIRMA:	REVISIÓN:		APROBADO:	28/07/2015	D.Martinez		
						DESIGNACIÓN:	tribex-1650x800x400-estandar			



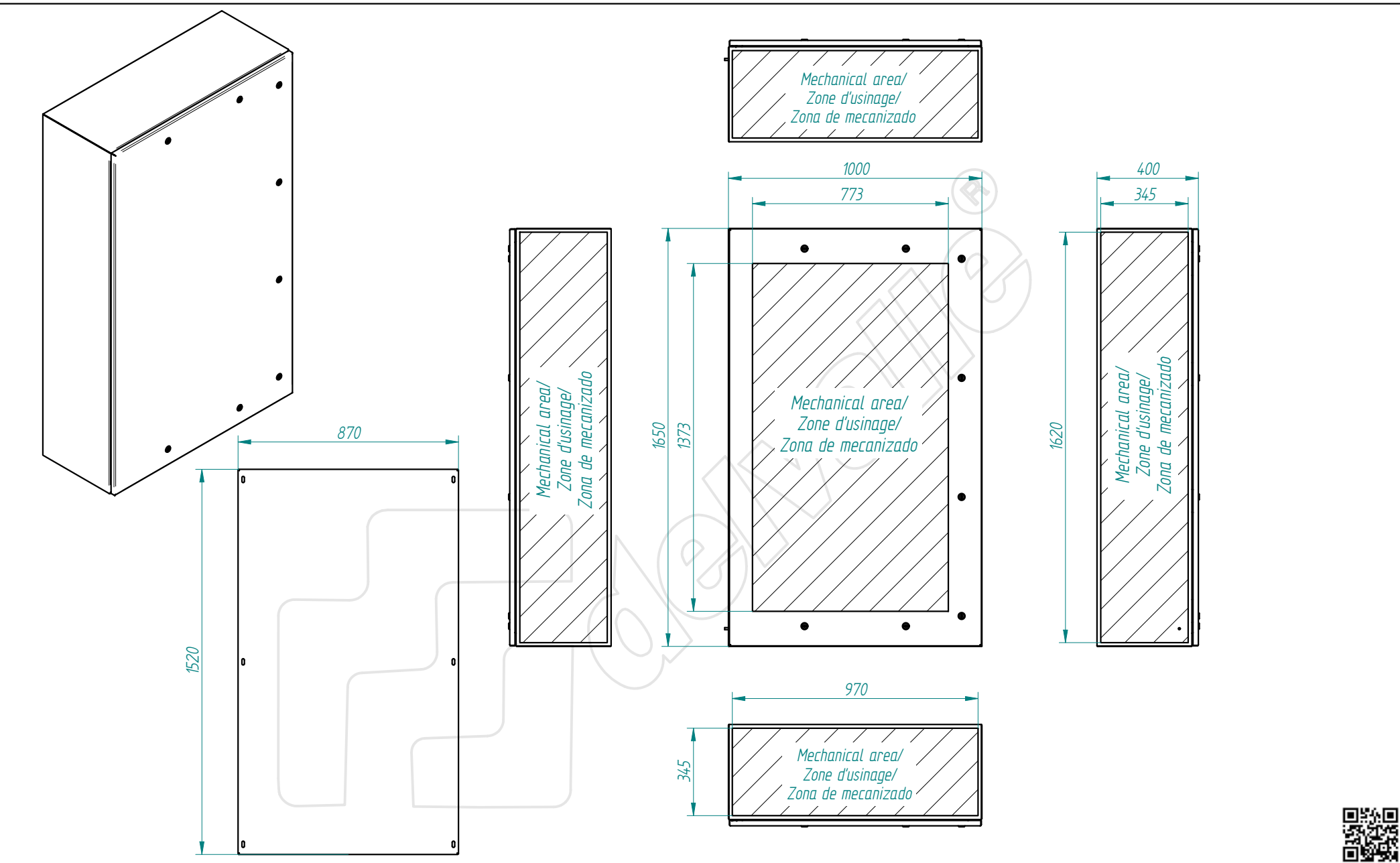

This present document and its contents are confidential, and are the exclusive intellectual and / or industrial property of DELVALLE. In addition to any technology, design, invention, work, process, know-how, calculation, manual, method, solution, idea, improvement, drawing, diagram, modification, contribution and, in short, any associated information or documentation involving industrial or intellectual property developed or supplied by DELVALLE on the occasion of the quote, order execution or incorporated into the design or operation of the supply. The recipient may not use such property in his favour or in that of a third party for purposes other than the fulfilment of the order and the operation and maintenance of the supply, without the prior written consent of DELVALLE. It is strictly forbidden to totally or partially reproduce this document and to misuse it and / or to show it to third parties. The infringing parties shall be required to pay the corresponding compensation for damages, and any other legal or criminal responsibilities, the infringement may give rise to.

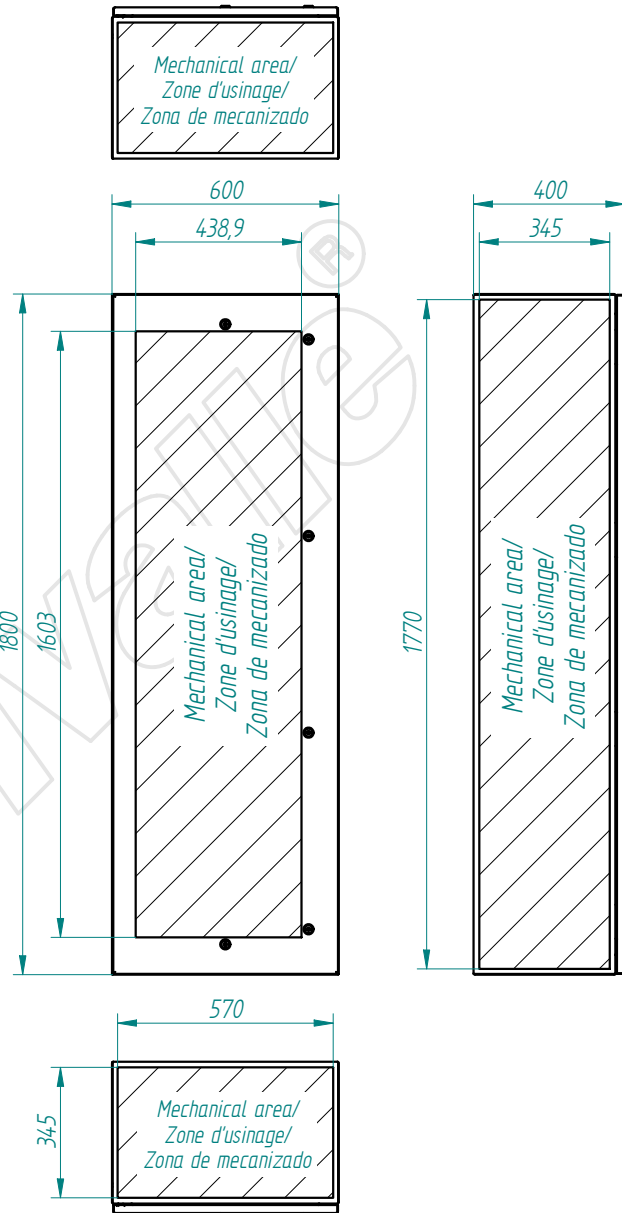
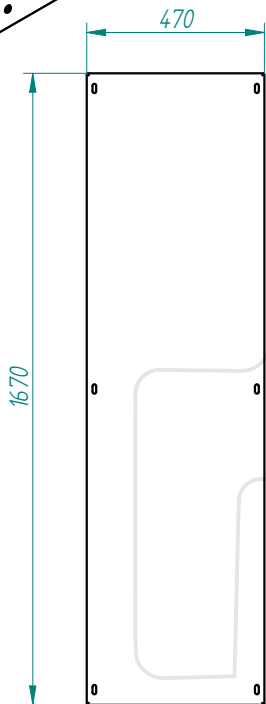
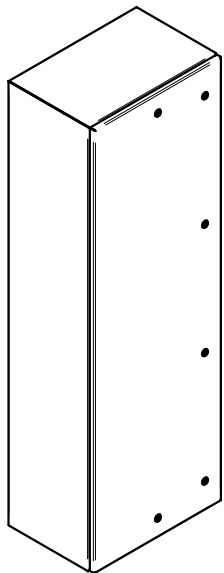

TOLERANCIA GENERAL DE MECANIZACION segun DIN 7168					Referencia: - plegado: acabado:	DIBUJADO:	FECHA:	FIRMA:	 Nº PLANO:
						APROBADO:	28/07/2015	D.Martinez	
	Creación del documento	28/07/2015	D.MTNEZ	A		DESIGNACIÓN:	tribex-1650x1000x400-estandar		
	MODIFICACIONES	FECHA:	FIRMA:	REVISIÓN:					

This present document and its contents are confidential and are the exclusive intellectual and / or industrial property of DELVALLE . In addition to any technology, design, invention, work, process, know-how, calculation, manual, method, solution, idea, improvement, drawing, diagram, modification, contribution and, in short, any associated information involving industrial or intellectual property developed or supplied by DELVALLE on the occasion of the quote, order execution or incorporated into the design or operation of the supply. The recipient may not use such property in his favour or in that of a third party for purposes other than the fulfilment of the order and the operation and maintenance of the supply, without the prior written consent of DELVALLE. It is strictly forbidden to totally or partially reproduce this document and to misuse it and / or to show it to third parties. The infringing parties shall be required to pay the corresponding compensation for damages, and any other legal or criminal responsible for the infringement may give rise to.



TOLERANCIA GENERAL DE MECANIZACION según DIN 7168					Referencia:	DIBUJADO:	FECHA:	FIRMA:	
						APROBADO:	28/03/2022	D.Martínez	
	Creación del documento	28/03/2022	D.MTNEZ	A	-	DESIGNACIÓN:			Nº PLANO:
	MODIFICACIONES	FECHA:	FIRMA:	REVISIÓN:	plegado: acabado:	tribex-1800x600x400-estandar			



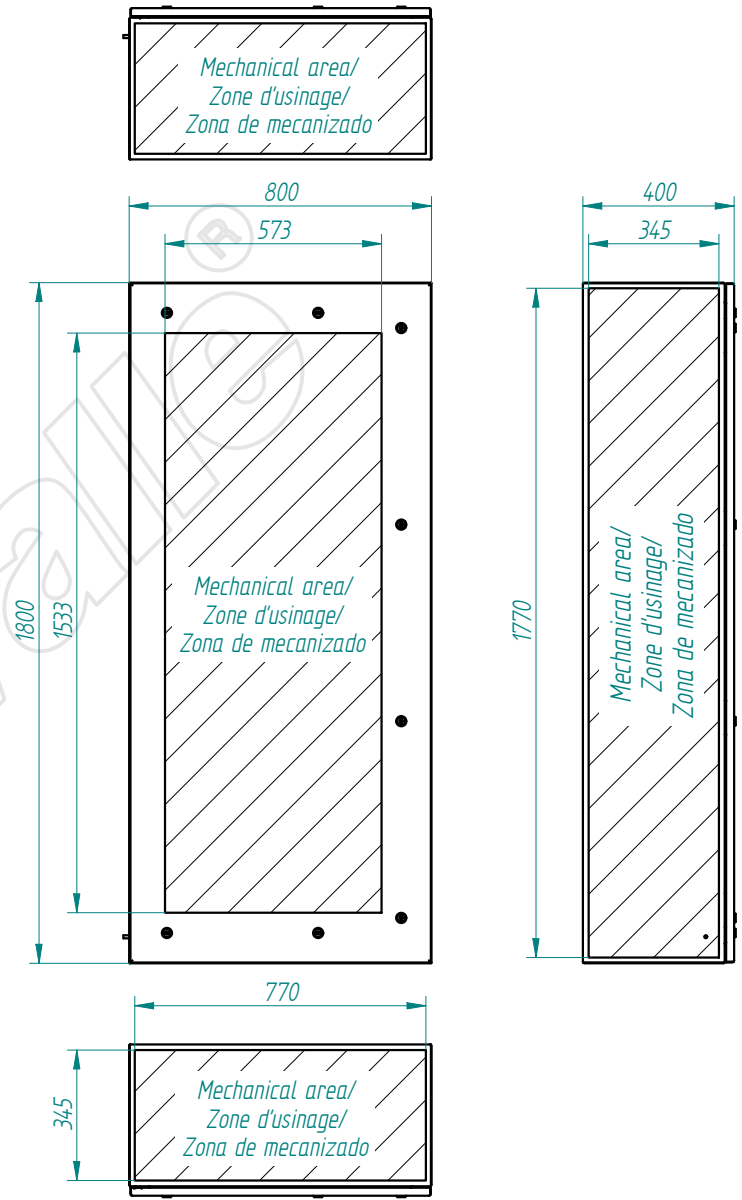
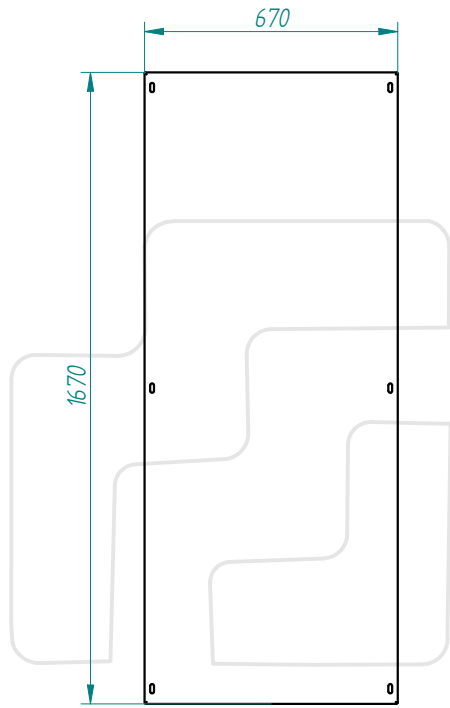
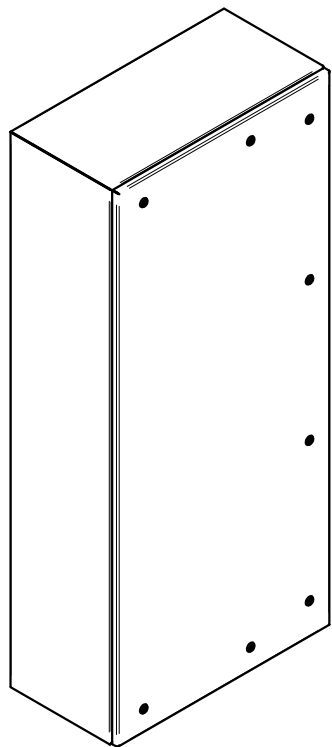

This present document and its contents are confidential, and are the exclusive intellectual and / or industrial property of DELVALLE. In addition to any technology, design, invention, work, process, know-how, calculation, manual, method, solution, idea, improvement, drawing, diagram, modification, contribution and, in short, any associated information involving industrial or intellectual property developed or supplied by DELVALLE on the occasion of the quote, order execution or incorporated into the design or operation of the supply. The recipient may not use such property in his favour or in that of a third party for purposes other than the fulfilment of the order and the operation and maintenance of the supply, without the prior written consent of DELVALLE. It is strictly forbidden to totally or partially reproduce this document and to misuse it and / or to show it to third parties. The infringing parties shall be required to pay the corresponding compensation for damages, and any other legal or criminal responsibility is the infringement may give rise to.

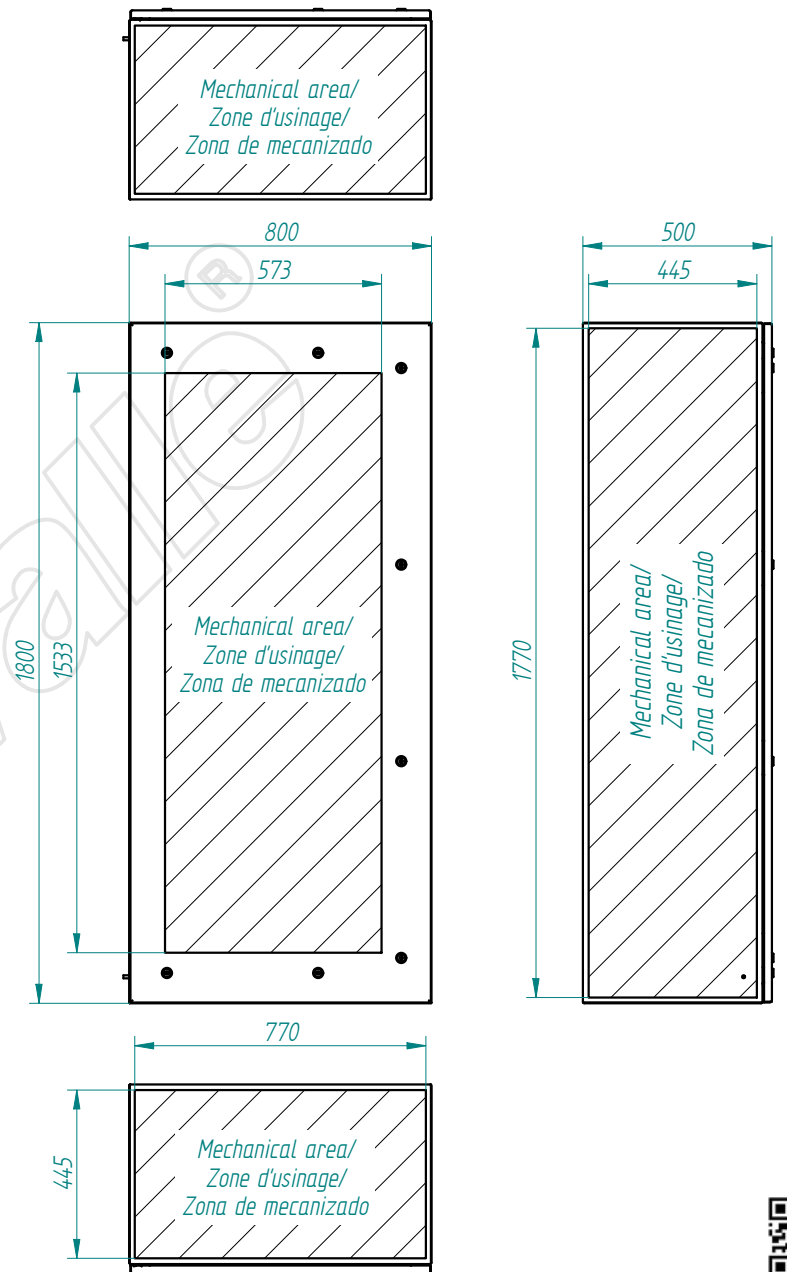
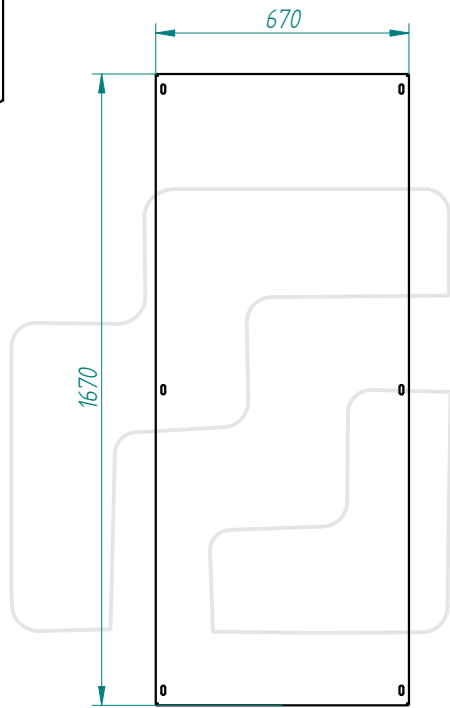
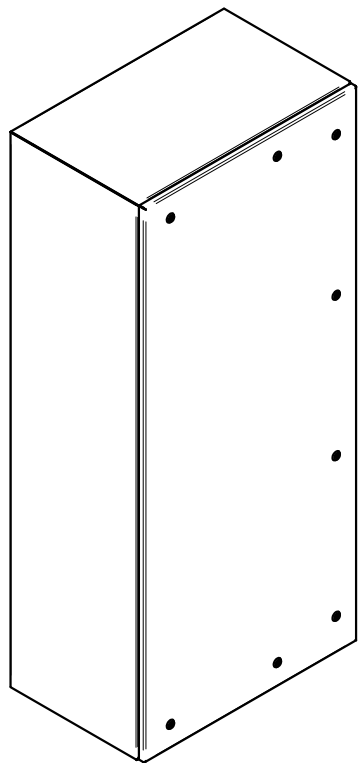

TOLERANCIA GENERAL DE MECANIZACION según DIN 7168					Referencia:		FECHA:	FIRMA:	
						DIBUJADO:	28/07/2015	D.Martínez	
						APROBADO:	28/07/2015	D.Martínez	
	Creación del documento	28/07/2015	D.MTNEZ	A	-	DESIGNACIÓN:			Nº PLANO:
	MODIFICACIONES	FECHA:	FIRMA:	REVISIÓN:	plegado: acabado:	tribex-1800x800x400-estandar			

This present document and its contents are confidential, and are the exclusive intellectual and / or industrial property of DELVALLE ., in addition to any technology, design, invention, work, process, know-how, calculation, manual, method, solution, idea, improvement, drawing, diagram, modification, contribution and, in short, any associated information involving industrial or intellectual property developed or supplied by DELVALLE on the occasion of the quote, order execution or incorporated into the design or operation of the supply. The recipient may not use such property in his favour or in that of a third party for purposes other than the fulfilment of the order and the operation and maintenance of the supply, without the prior written consent of DELVALLE. It is strictly forbidden to totally or partially reproduce this document and to misuse it and / or to show it to third parties. The infringing parties shall be required to pay the corresponding compensation for damages, and any other legal or criminal responsibility is the infringement may give rise to.



TOLERANCIA GENERAL DE MECANIZACION segun DIN 7168					Referencia: - plegado: - acabado:	DIBUJADO:	FECHA:	FIRMA:	
						APROBADO:	28/07/2015	D.Martinez	
	Creación del documento	28/07/2015	D.MTNEZ	A		DESIGNACIÓN:	tribex-1800x800x500-estandar		
	MODIFICACIONES	FECHA:	FIRMA:	REVISIÓN:					

This present document and its contents are confidential, and are the exclusive intellectual and / or industrial property of DELVALLE ., in addition to any technology, design, invention, work, process, know-how, calculation, manual, method, solution, idea, improvement, drawing, diagram, modification, contribution and, in short, any associated information involving industrial or intellectual property developed or supplied by DELVALLE on the occasion of the quote, order execution or incorporated into the design or operation of the supply. The recipient may not use such property in his favour or in that of a third party for purposes other than the fulfilment of the order and the operation and maintenance of the supply, without the prior written consent of DELVALLE. It is strictly forbidden to totally or partially reproduce this document and to misuse it and / or to show it to third parties. The infringing parties shall be required to pay the corresponding compensation for damages, and any other legal or criminal, responsible and the infringement may give rise to.

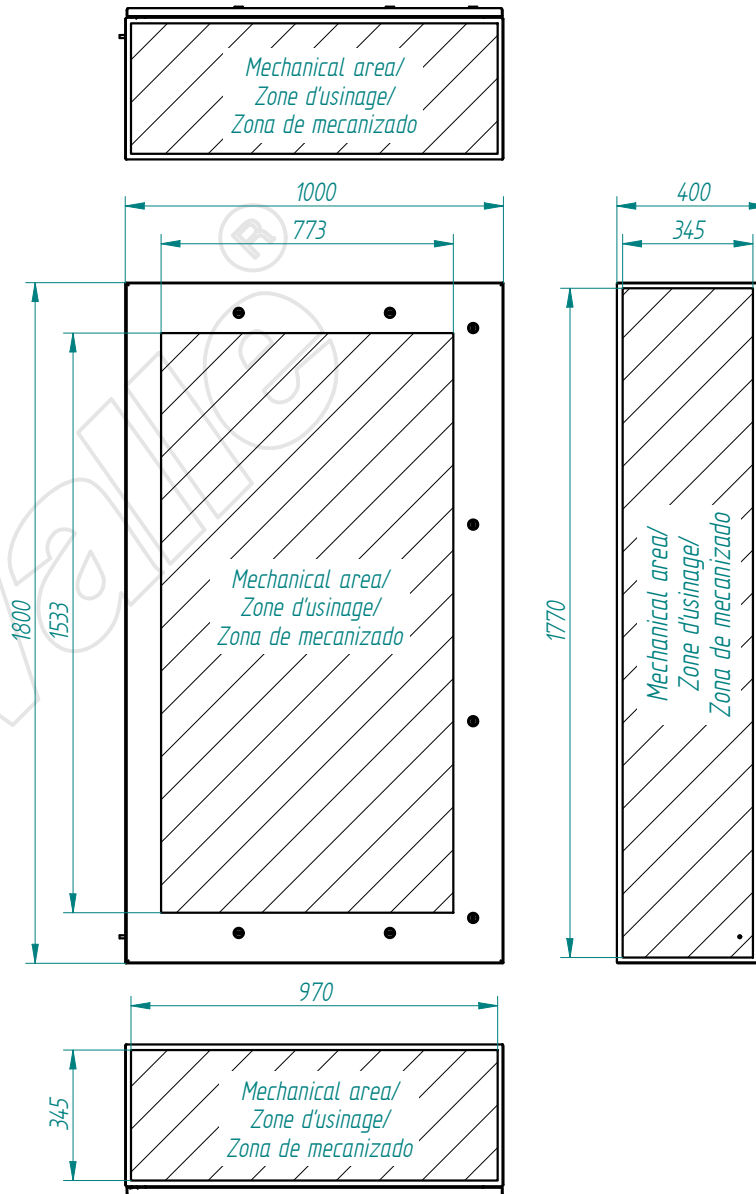
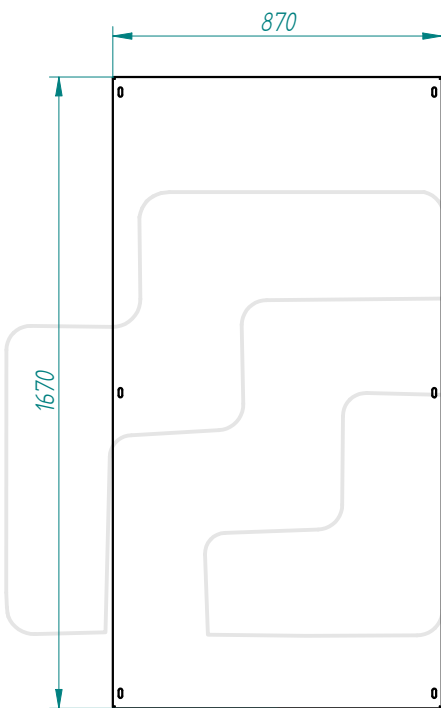
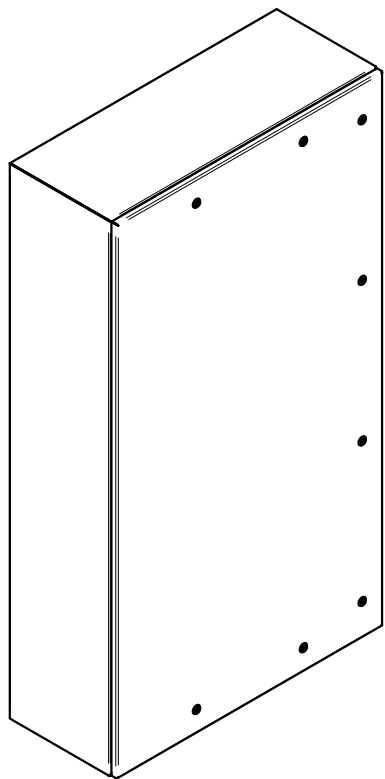

TOLERANCIA GENERAL DE MECANIZACION según DIN 7168					Referencia:		FECHA:	FIRMA:	
							DIBUJADO:	D.Martínez	
						APROBADO:	28/07/2015	D.Martínez	
	Creación del documento	28/07/2015	D.MTNEZ	A	-	DESIGNACIÓN:			Nº PLANO:
	MODIFICACIONES	FECHA:	FIRMA:	REVISIÓN:	plegado: acabado:	tribex-1800x1000x400-estandar			

This present document and its contents are confidential, and are the exclusive intellectual and / or industrial property of DELVALLE ., in addition to any technology, design, invention, work, process, know-how, calculation, manual, method, solution, idea, improvement, drawing, diagram, modification, contribution and, in short, any associated information involving industrial or intellectual property developed or supplied by DELVALLE on the occasion of the quote, order execution or incorporated into the design or operation of the supply. The recipient may not use such property in his favour or in that of a third party for purposes other than the fulfilment of the order and the operation and maintenance of the supply, without the prior written consent of DELVALLE. It is strictly forbidden to totally or partially reproduce this document and to misuse it and / or to show it to third parties. The infringing parties shall be required to pay the corresponding compensation for damages, and any other legal or criminal responsibilities, the infringement may give rise to.

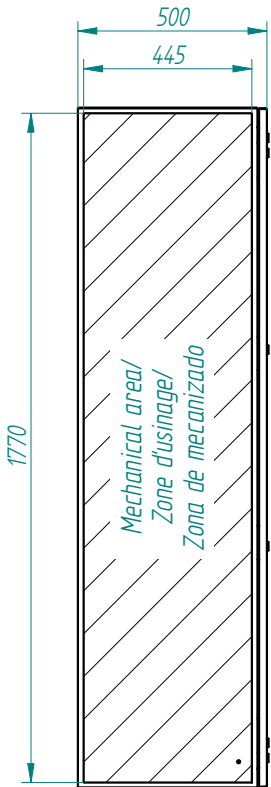
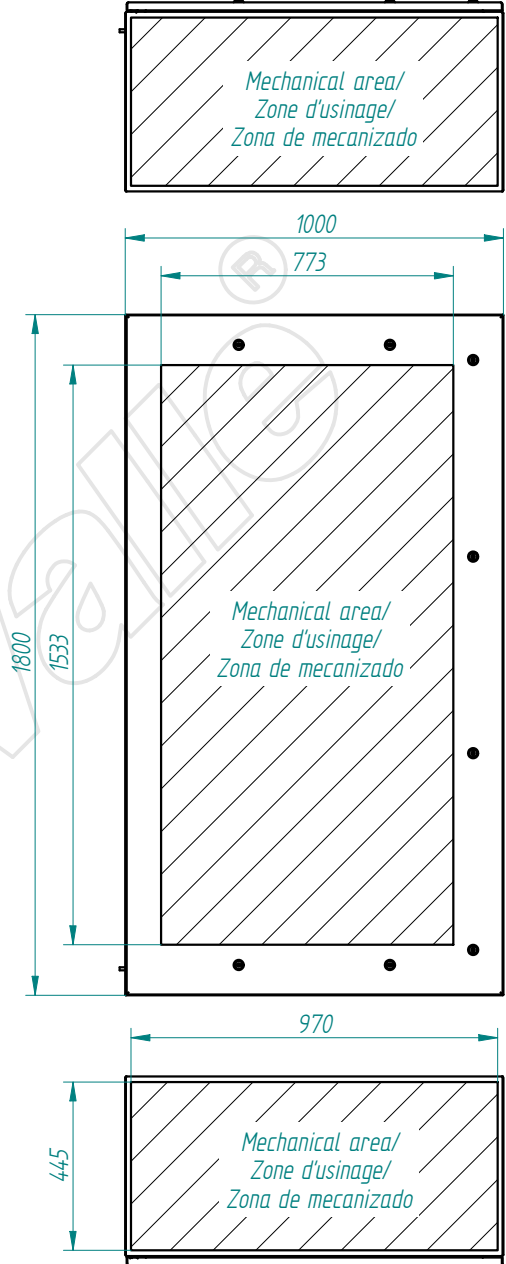
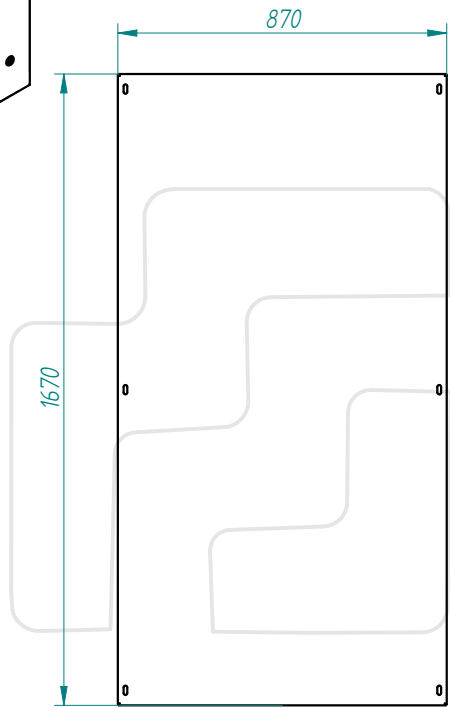
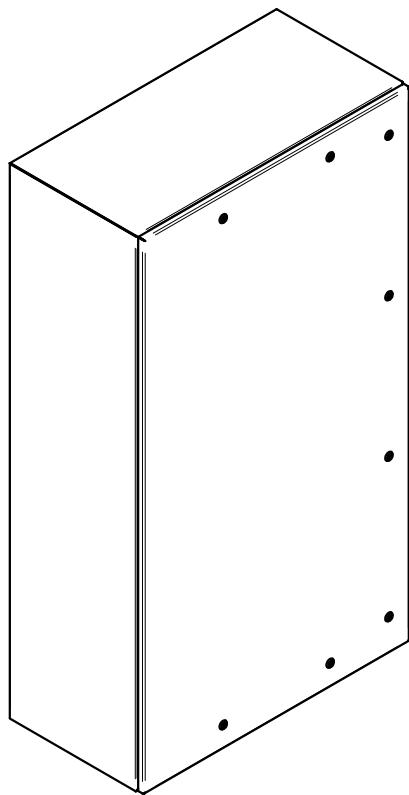

TOLERANCIA GENERAL DE MECANIZACION segun DIN 7168					Referencia:	DIBUJADO:	FECHA:	FIRMA:	
							28/07/2015	D.Martinez	
	Creación del documento	28/07/2015	D.MTNEZ	A	-	APROBADO:	28/07/2015	D.Martinez	Nº PLANO:
	MODIFICACIONES	FECHA:	FIRMA:	REVISIÓN:	plegado: acabado:	DESIGNACIÓN:			
						tribex-1800x1000x500-estandar			

This present document and its contents are confidential and are the exclusive intellectual and / or industrial property of DELVALLE . In addition to any technology, design, invention, work, process, know-how, calculation, manual, method, solution, idea, improvement, drawing, diagram, modification, contribution and, in short, any associated information involving industrial or intellectual property developed or supplied by DELVALLE on the occasion of the quote, order execution or incorporated into the design or operation of the supply. The recipient may not use such property in his favour or in that of a third party for purposes other than the fulfilment of the order and the operation and maintenance of the supply, without the prior written consent of DELVALLE. It is strictly forbidden to totally or partially reproduce this document and to misuse it and / or to show it to third parties. The infringing parties shall be required to pay the corresponding compensation for damages, and any other legal or criminal, responsible and the infringement may give rise to.

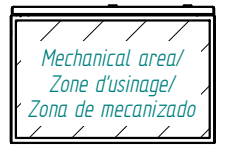
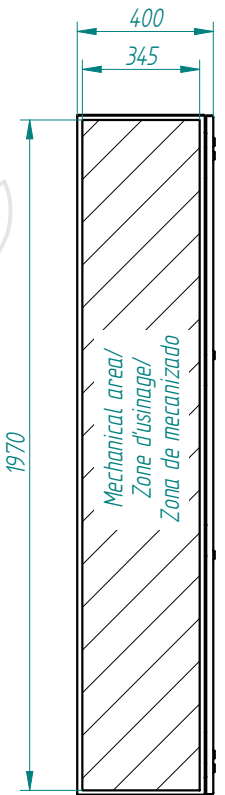
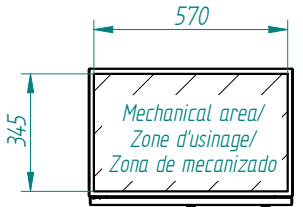
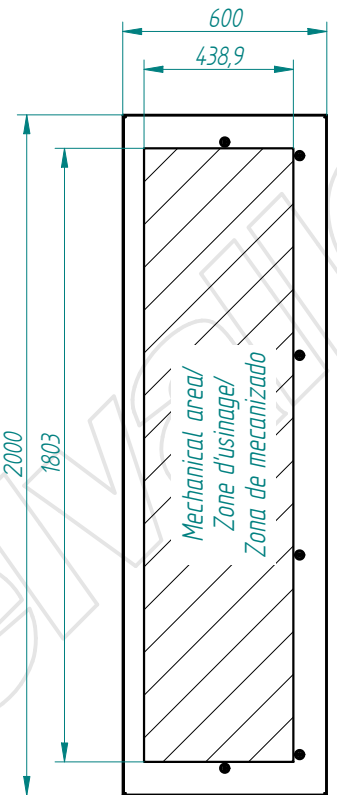
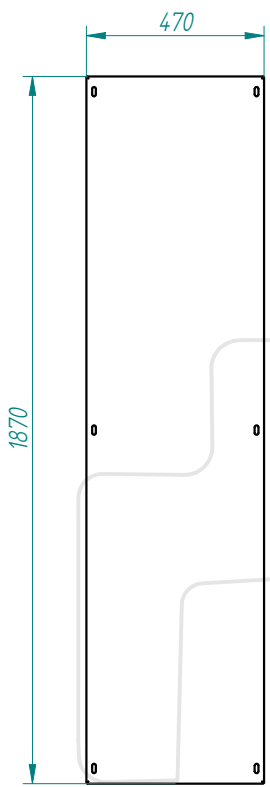
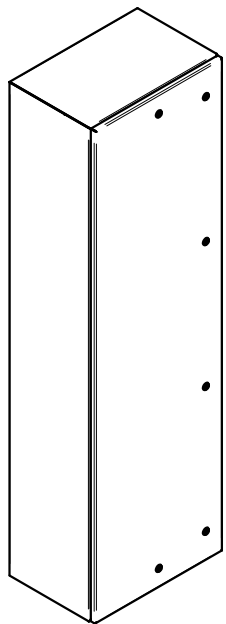

TOLERANCIA GENERAL DE MECANIZACION según DIN 7168	Creación del documento	28/03/2022	D.MTNEZ	A	Referencia: - plegado: acabado:	DIBUJADO:	28/03/2022	FIRMA:	D.Martínez	Nº PLANO:
	MODIFICACIONES	FECHA:	FIRMA:	REVISIÓN:		APROBADO:	28/03/2022	D.Martínez		
						DESIGNACIÓN:			tribex-2000x600x400-estandar	



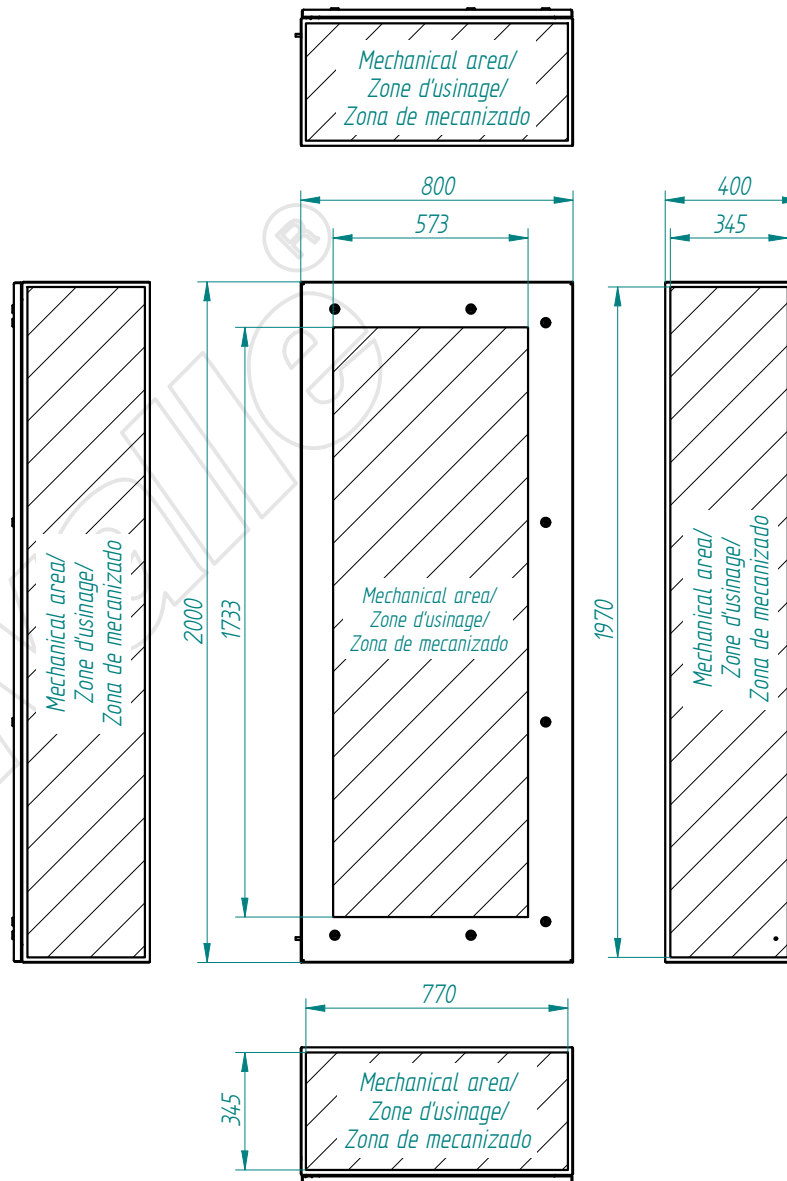
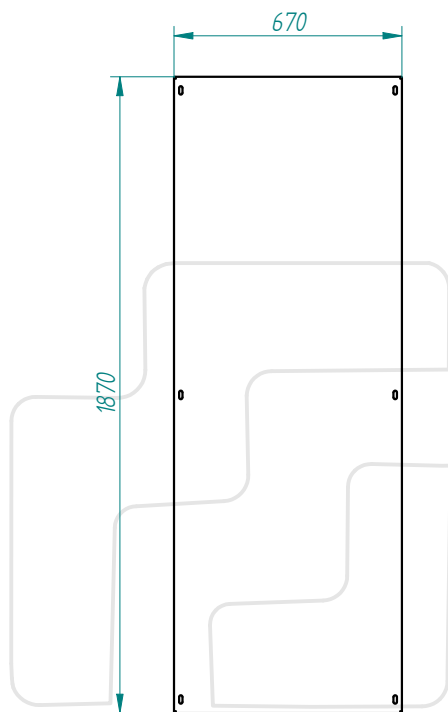
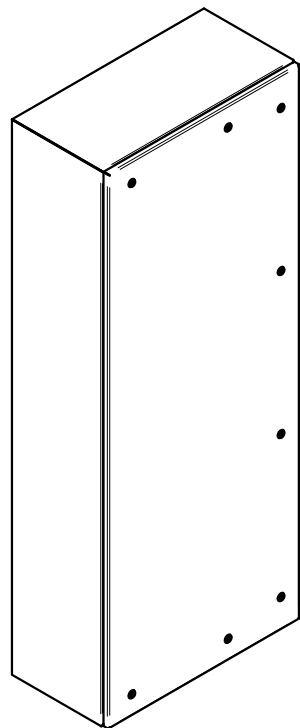

This present document and its contents are confidential, and are the exclusive intellectual and / or industrial property of DELVALLE. In addition to any technology, design, invention, work, process, know-how, calculation, manual, method, solution, idea, improvement, drawing, diagram, modification, contribution and, in short, any associated information or documentation involving industrial or intellectual property developed or supplied by DELVALLE on the occasion of the quote, order execution or incorporated into the design or operation of the supply. The recipient may not use such property in his favour or in that of a third party for purposes other than the fulfilment of the order and the operation and maintenance of the supply, without the prior written consent of DELVALLE. It is strictly forbidden to totally or partially reproduce this document and to misuse it and / or to show it to third parties. The infringing parties shall be required to pay the corresponding compensation for damages, and any other legal or criminal responsibility is the infringement may give rise to.

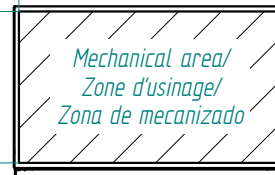
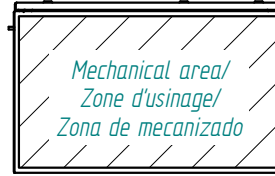
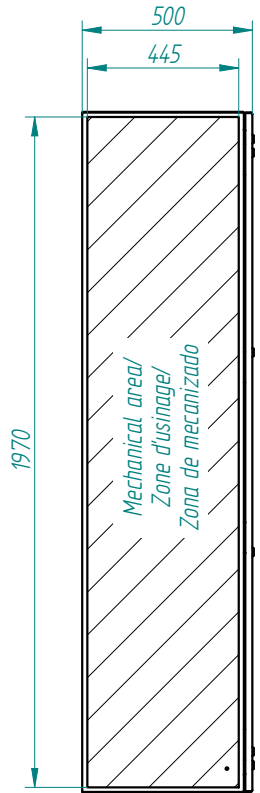
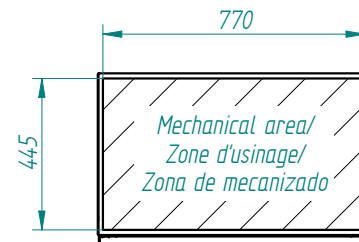
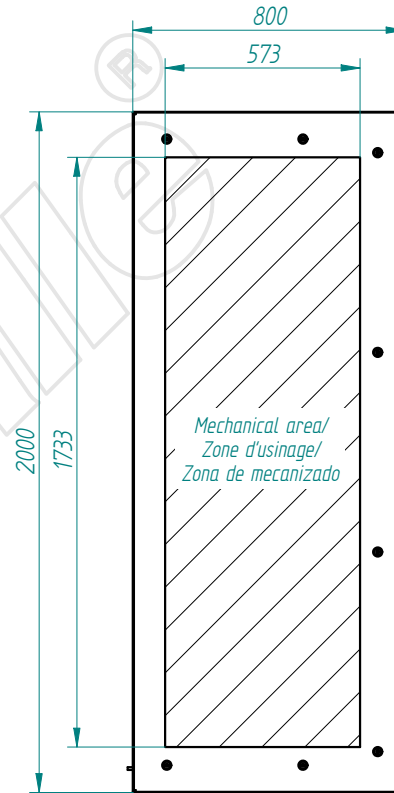
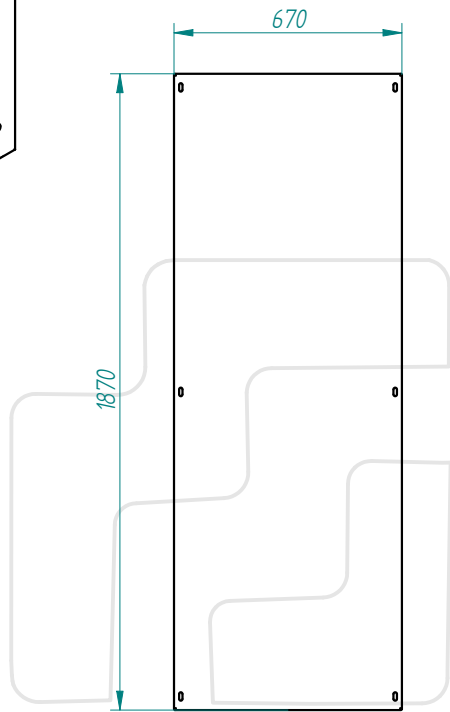
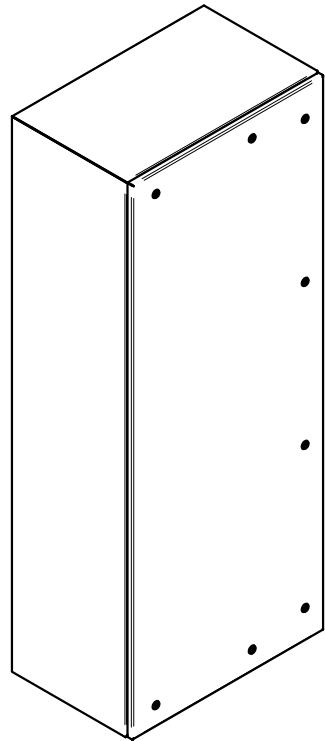

TOLERANCIA GENERAL DE MECANIZACION segun DIN 7168					Referencia:		FECHA:	FIRMA:	
							DIBUJADO: 28/07/2015	D.Martinez	
							APROBADO: 28/07/2015	D.Martinez	
	Creación del documento	28/07/2015	D.MTNEZ	A	-	DESIGNACIÓN:			Nº PLANO:
	MODIFICACIONES	FECHA:	FIRMA:	REVISIÓN:	plegado: acabado:	tribex-2000x800x400-estandar			

This present document and its contents are confidential, and are the exclusive intellectual and / or industrial property of DELVALLE. In addition to any technology, design, invention, work, process, know-how, calculation, manual, method, solution, idea, improvement, drawing, diagram, modification, contribution and, in short, any associated information involving industrial or intellectual property developed or supplied by DELVALLE on the occasion of the quote, order execution or incorporated into the design or operation of the supply. The recipient may not use such property in his favour or in that of a third party for purposes other than the fulfilment of the order and the operation and maintenance of the supply, without the prior written consent of DELVALLE. It is strictly forbidden to totally or partially reproduce this document and to misuse it and / or to show it to third parties. The infringing parties shall be required to pay the corresponding compensation for damages, and any other legal or criminal responsibility is the infringement may give rise to.



TOLERANCIA GENERAL DE MECANIZACION segun DIN 7168					Referencia:		FECHA:	FIRMA:	
							DIBUJADO:	28/07/2015	
						APROBADO:	28/07/2015	D.Martinez	
	Creación del documento	28/07/2015	D.MTNEZ	A	-	DESIGNACIÓN:			Nº PLANO:
	MODIFICACIONES	FECHA:	FIRMA:	REVISIÓN:	plegado: acabado:	tribex-2000x800x500-estandar			



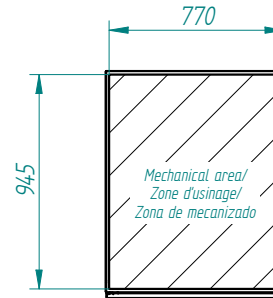
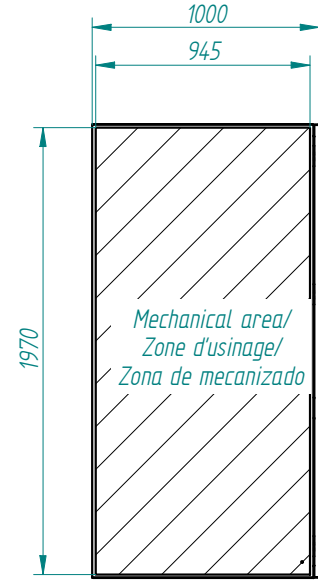
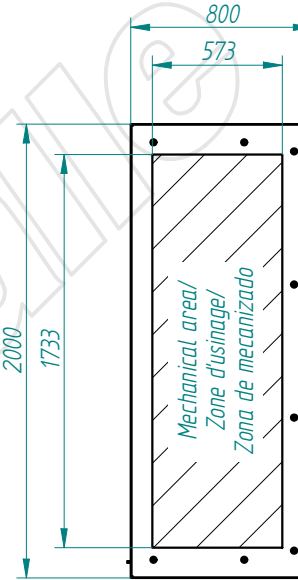
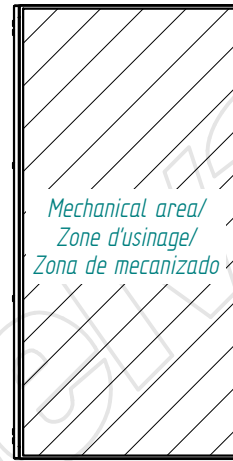
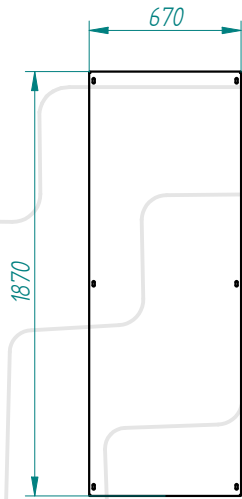
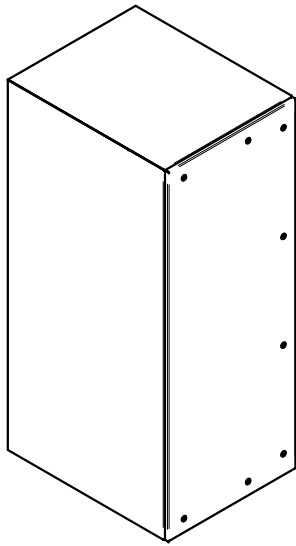

This present document and its contents are confidential, and are the exclusive intellectual and / or industrial property of DELVALLE. In addition to any technology, design, invention, work, process, know-how, calculation, manual, method, solution, idea, improvement, drawing, diagram, modification, contribution and, in short, any associated information or documentation involving industrial or intellectual property developed or supplied by DELVALLE on the occasion of the quote, order execution or incorporated into the design or operation of the supply. The recipient may not use such property in his favour or in that of a third party for purposes other than the fulfilment of the order and the operation and maintenance of the supply, without the prior written consent of DELVALLE. It is strictly forbidden to totally or partially reproduce this document and to misuse it and / or to show it to third parties. The infringing parties shall be required to pay the corresponding compensation for damages and any other legal or criminal responsibility. The infringement may give rise to.

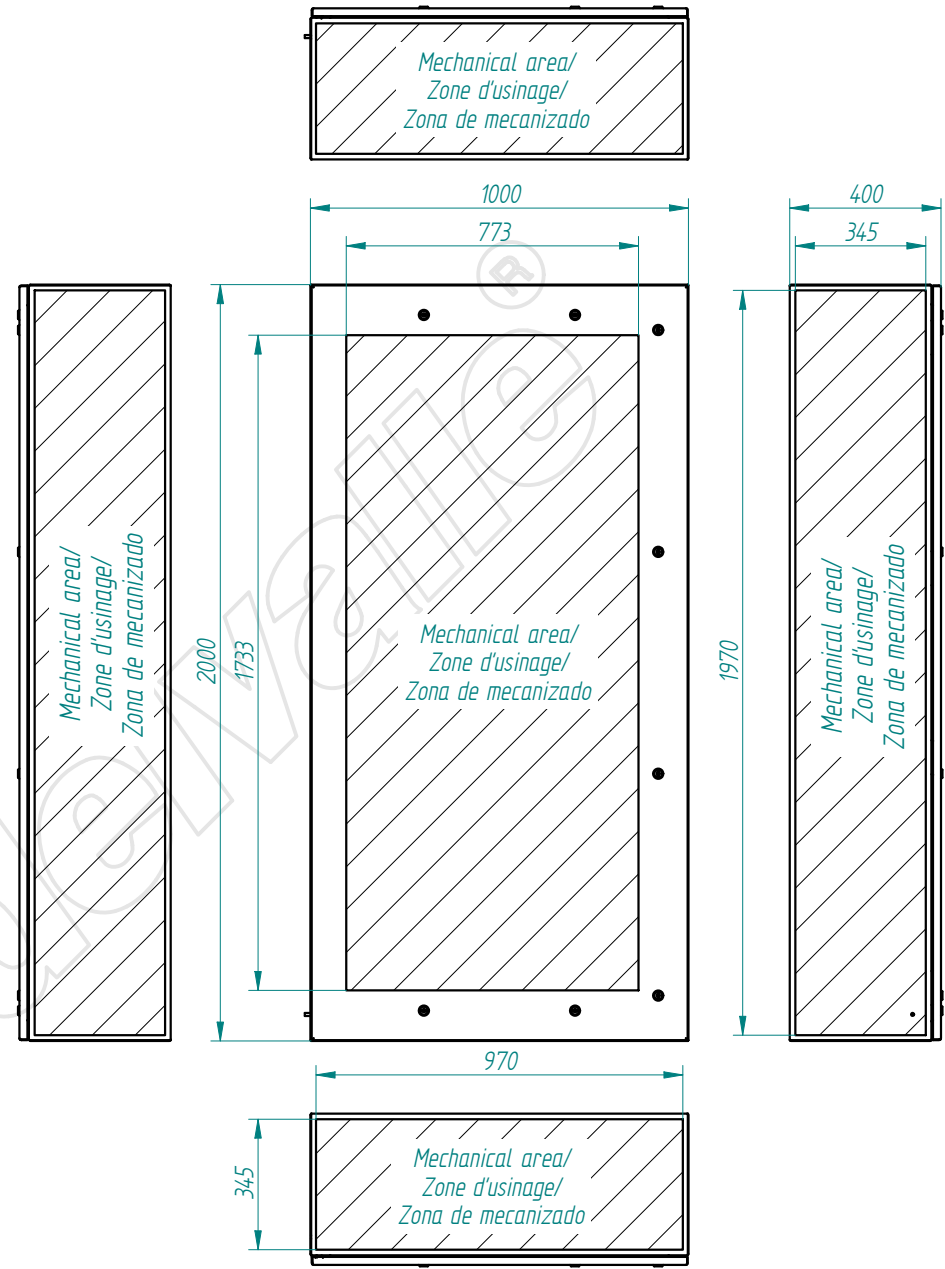
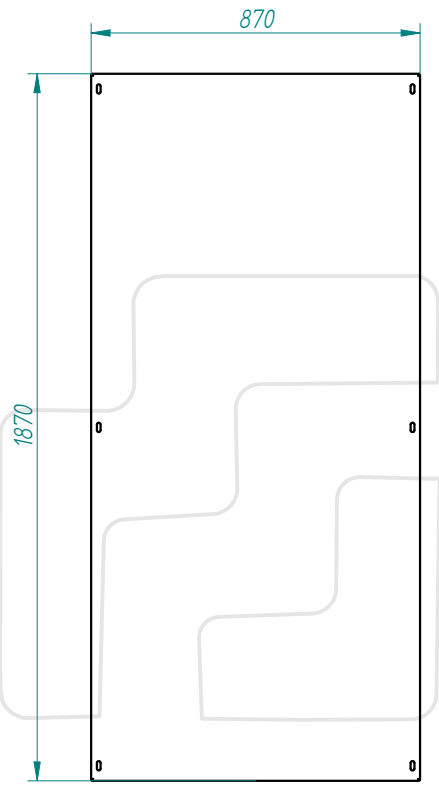
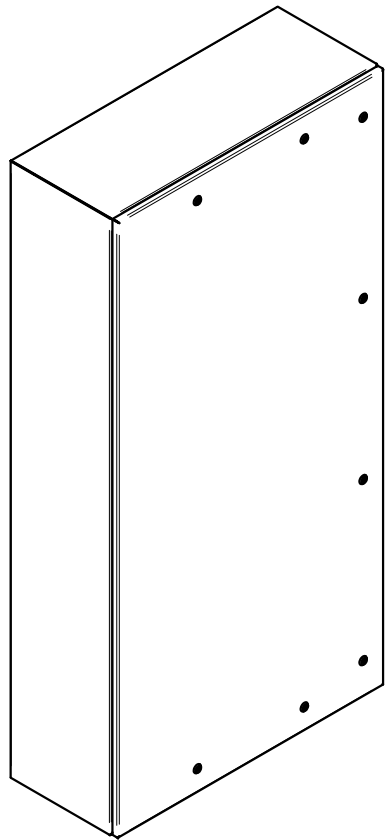

TOLERANCIA GENERAL DE MECANIZACION segun DIN 7168					Referencia:		FECHA:	FIRMA:	
						DIBUJADO:	28/07/2015	D.Martinez	
						APROBADO:	28/07/2015	D.Martinez	
	Creación del documento	28/07/2015	D.MTNEZ	A	-	DESIGNACIÓN:			Nº PLANO:
	MODIFICACIONES	FECHA:	FIRMA:	REVISIÓN:	plegado: acabado:	tribex-2000x800x1000-estandar			

This present document and its contents are confidential, and are the exclusive intellectual and / or industrial property of DELVALLE ., in addition to any technology, design, invention, work, process, know-how, calculation, manual, method, solution, idea, improvement, drawing, diagram, modification and, in short, any associated information involving industrial or intellectual property developed or supplied by DELVALLE on the occasion of the quote, order execution or incorporated into the design or operation of the supply. The recipient may not use such property in his favour or in that of a third party for purposes other than the fulfilment of the order and the operation and maintenance of the supply, without the prior written consent of DELVALLE. It is strictly forbidden to totally or partially reproduce this document and to misuse it and / or to show it to third parties. The infringing parties shall be required to pay the corresponding compensation for damages and any other legal or criminal responsibility. The infringement may give rise to.



TOLERANCIA GENERAL DE MECANIZACION segun DIN 7168					Referencia: - plegado: acabado:	DIBUJADO:	FECHA:	FIRMA:	 Nº PLANO:
						APROBADO:	28/07/2015	D.Martinez	
	Creación del documento	28/07/2015	D.MTNEZ	A		DESIGNACIÓN:	tribex-2000x1000x400-estandar		
	MODIFICACIONES	FECHA:	FIRMA:	REVISIÓN:					

This present document and its contents are confidential, and are the exclusive intellectual and / or industrial property of DELVALLE. In addition to any technology, design, invention, work, process, know-how, calculation, manual, method, solution, idea, improvement, drawing, diagram, modification, contribution and, in short, any associated information involving industrial or intellectual property developed or supplied by DELVALLE on the occasion of the quote, order execution or incorporated into the design or operation of the supply. The recipient may not use such property in his favour or in that of a third party for purposes other than the fulfilment of the order and the operation and maintenance of the supply, without the prior written consent of DELVALLE. It is strictly forbidden to totally or partially reproduce this document and to misuse it and / or to show it to third parties. The infringing parties shall be required to pay the corresponding compensation for damages, and any other legal or criminal responsibility if the infringement may give rise to.

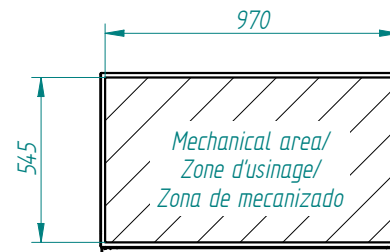
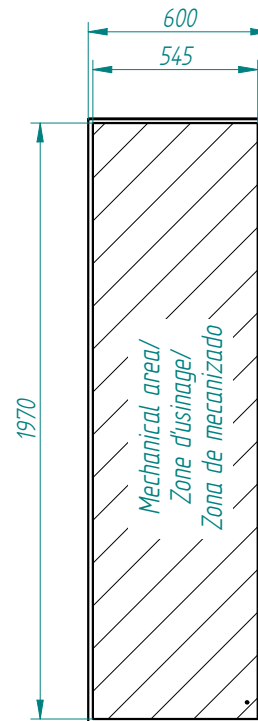
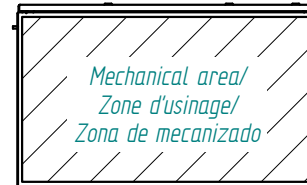
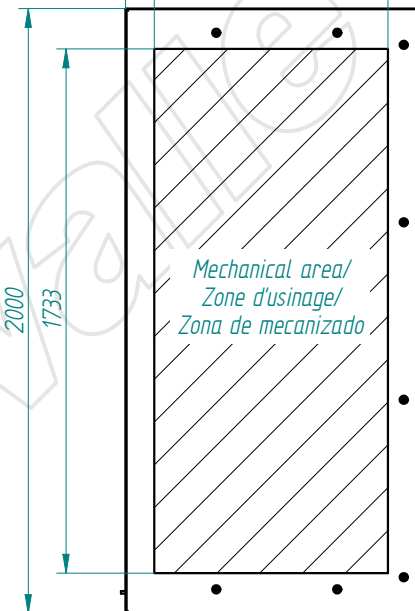
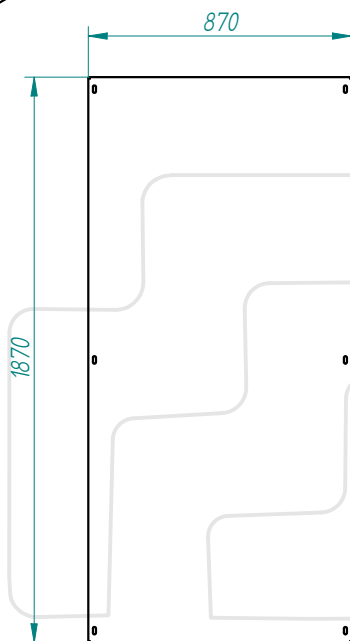
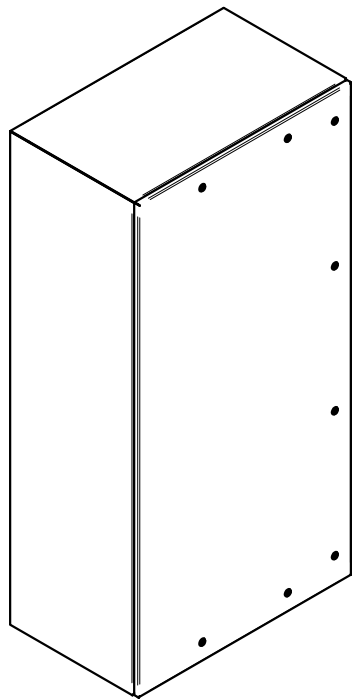

TOLERANCIA GENERAL DE MECANIZACION segun DIN 7168					Referencia: - plegado: acabado:	DIBUJADO:	FECHA:	FIRMA:	 Nº PLANO:
						APROBADO:	28/07/2015	D.Martinez	
	Creación del documento	28/07/2015	D.MTNEZ	A		DESIGNACIÓN:	tribex-2000x1000x600-estandar	D.Martinez	
	MODIFICACIONES	FECHA:	FIRMA:	REVISIÓN:					

This present document and its contents are confidential, and are the exclusive intellectual and / or industrial property of DELVALLE. In addition to any technology, design, invention, work, process, know-how, calculation, manual, method, solution, idea, improvement, drawing, diagram, modification, contribution and, in short, any associated information involving industrial or intellectual property developed or supplied by DELVALLE on the occasion of the quote, order execution or incorporated into the design or operation of the supply. The recipient may not use such property in his favour or in that of a third party for purposes other than the fulfilment of the order and the operation and maintenance of the supply, without the prior written consent of DELVALLE. It is strictly forbidden to totally or partially reproduce this document and to misuse it and / or to show it to third parties. The infringing parties shall be required to pay the corresponding compensation for damages, and any other legal or criminal responsibility is the infringement may give rise to.

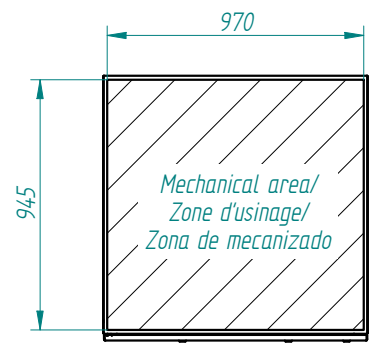
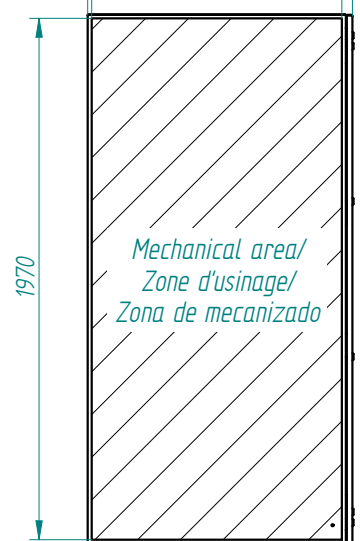
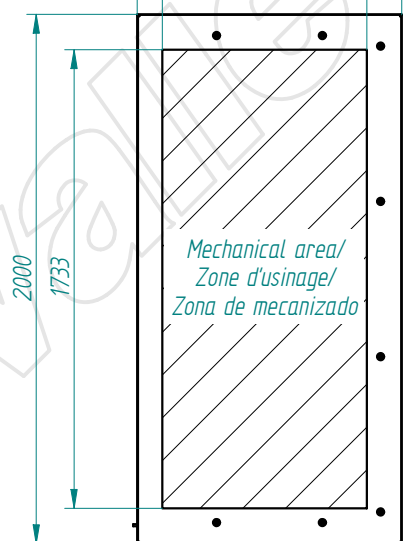
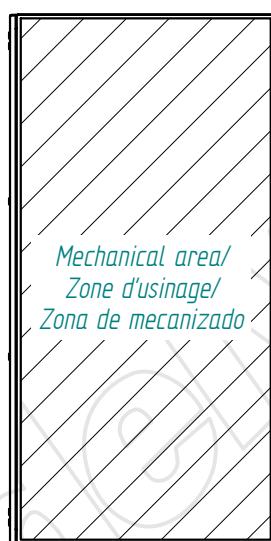
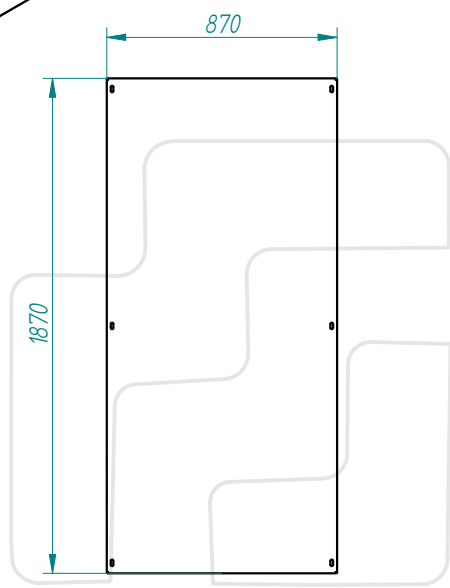
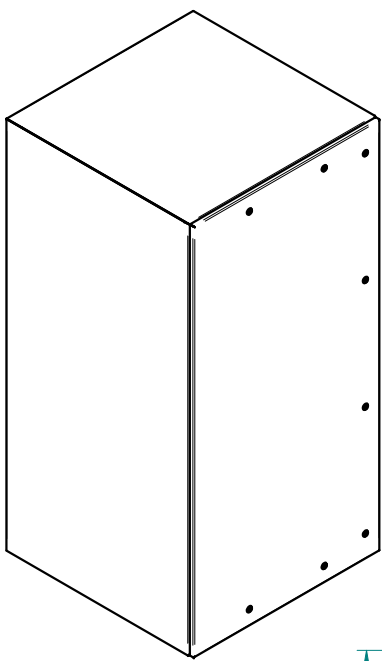

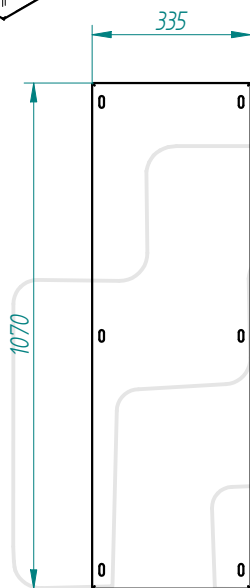
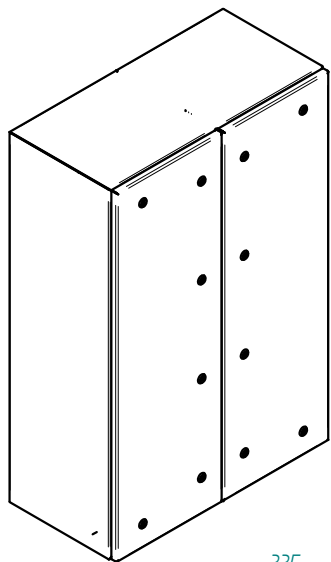

TOLERANCIA GENERAL DE MECANIZACION segun DIN 7168	Creación del documento	28/07/2015	D.MTNEZ	A	Referencia: - plegado: acabado:	DIBUJADO:	28/07/2015	FIRMA:	D.Martínez	 N° PLANO:
	MODIFICACIONES	FECHA:	FIRMA:	REVISIÓN:		APROBADO:	28/07/2015	D.Martínez		
						DESIGNACIÓN:	tribex-2000x1000x1000-estandar			

This present document and its contents are confidential, and are the exclusive intellectual and / or industrial property of DELVALLE . In addition to any technology, design, invention, work, process, know-how, calculation, manual, method, solution, idea, improvement, drawing, diagram, modification, combination and, in short, any associated information involving industrial or intellectual property developed or supplied by DELVALLE on the occasion of the quote, order execution or incorporated into the design or operation of the supply. The recipient may not use such property in his favour or in that of a third party for purposes other than the fulfilment of the order and the operation and maintenance of the supply, without the prior written consent of DELVALLE. It is strictly forbidden to totally or partially reproduce this document and to misuse it and / or to show it to third parties. The infringing parties shall be required to pay the corresponding compensation for damages, and any other legal or criminal, responsible. The infringement may give rise to.

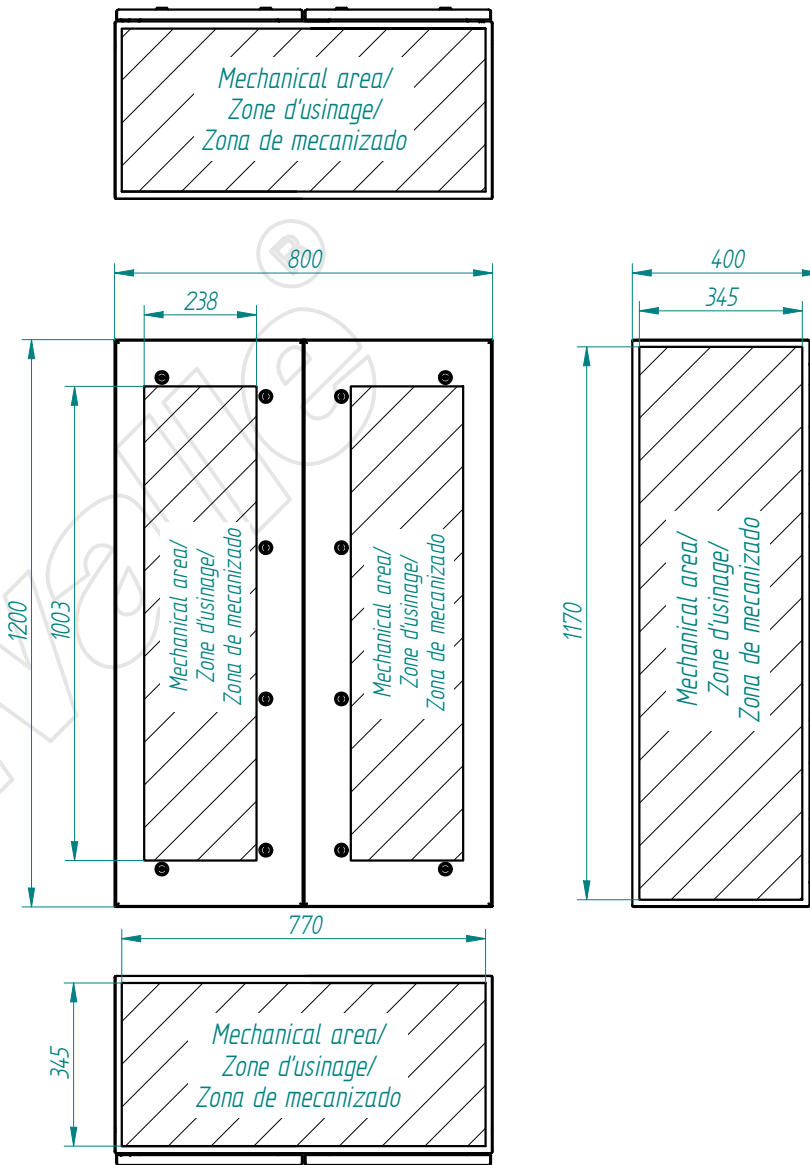

2 PLACAS



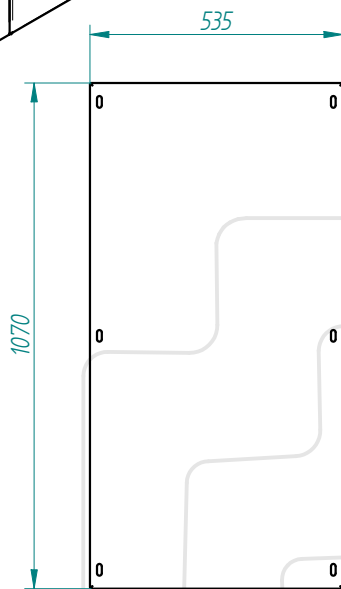
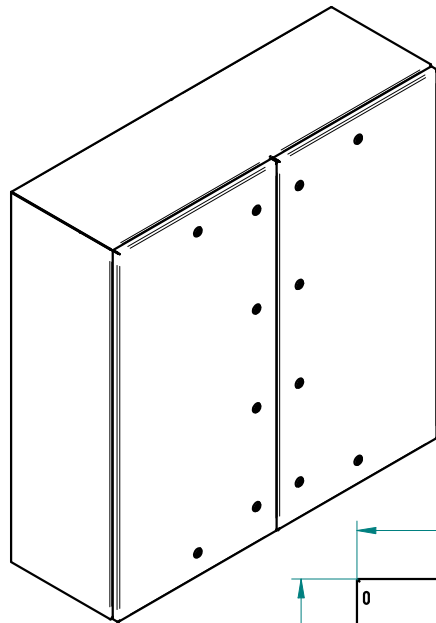

TOLERANCIA GENERAL DE MECANIZACION según DIN 7168					Referencia: - plegado: acabado:	DIBUJADO:	FECHA:	FIRMA:	 Nº PLANO:
						28/03/2022	D.Martínez		
						28/03/2022	D.Martínez		
	Creación del documento	28/03/2022	D.MTNEZ	A		DESIGNACIÓN:			
	MODIFICACIONES	FECHA:	FIRMA:	REVISIÓN:		tribex 2p-1200x800x400-estandar.			

This present document and its contents are confidential and are the exclusive intellectual and / or industrial property of DEVALLE. In addition to any technology, design, invention, work, process, know-how, calculation, manual, method, solution, idea, improvement, drawing, diagram, modification, combination and, in short, any associated information involving industrial or intellectual property developed or supplied by DEVALLE on the occasion of the quote, order execution or incorporated into the design or operation of the supply. The recipient may not use such property in his favour or in that of a third party for purposes other than the fulfilment of the order and the operation and maintenance of the supply, without the prior written consent of DEVALLE. It is strictly forbidden to totally or partially reproduce this document and to misuse it and / or to show it to third parties. The infringing parties shall be required to pay the corresponding compensation for damages and any other legal or criminal responsible. The infringement may give rise to.



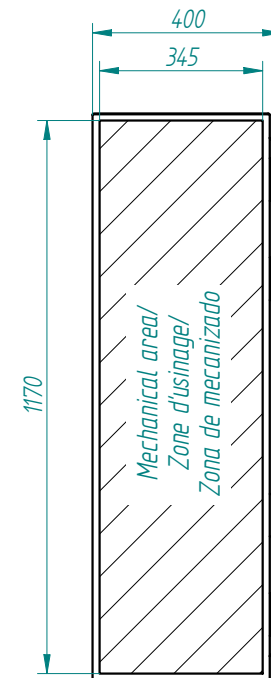
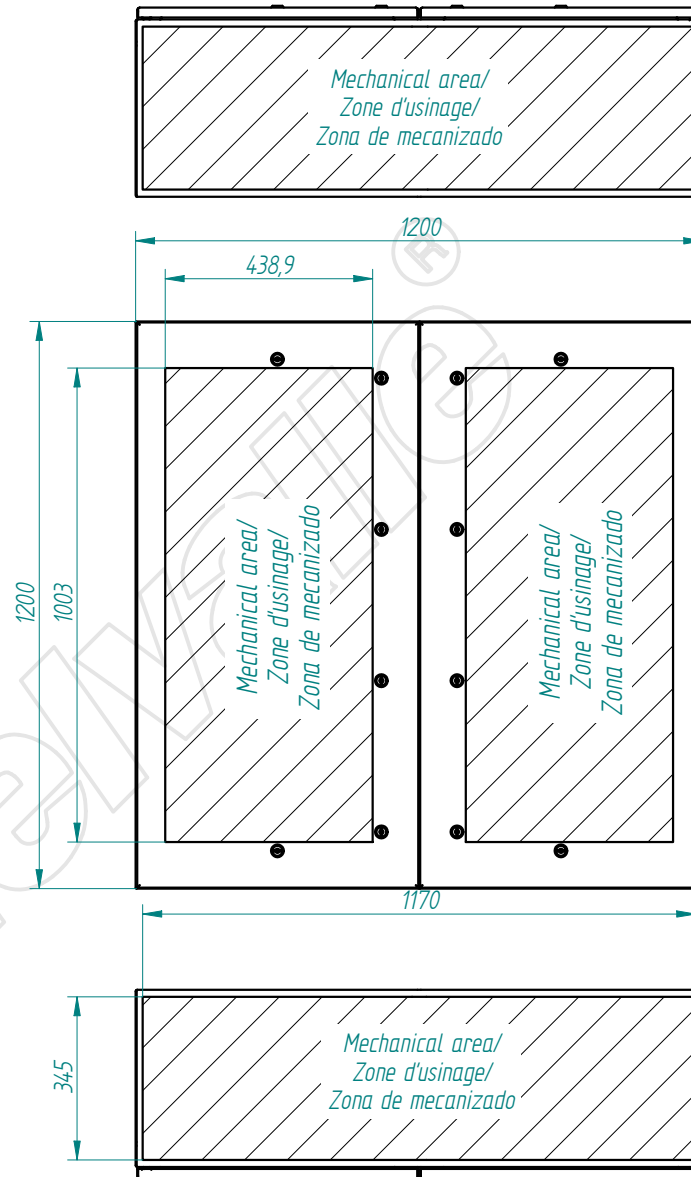

2 PLACAS

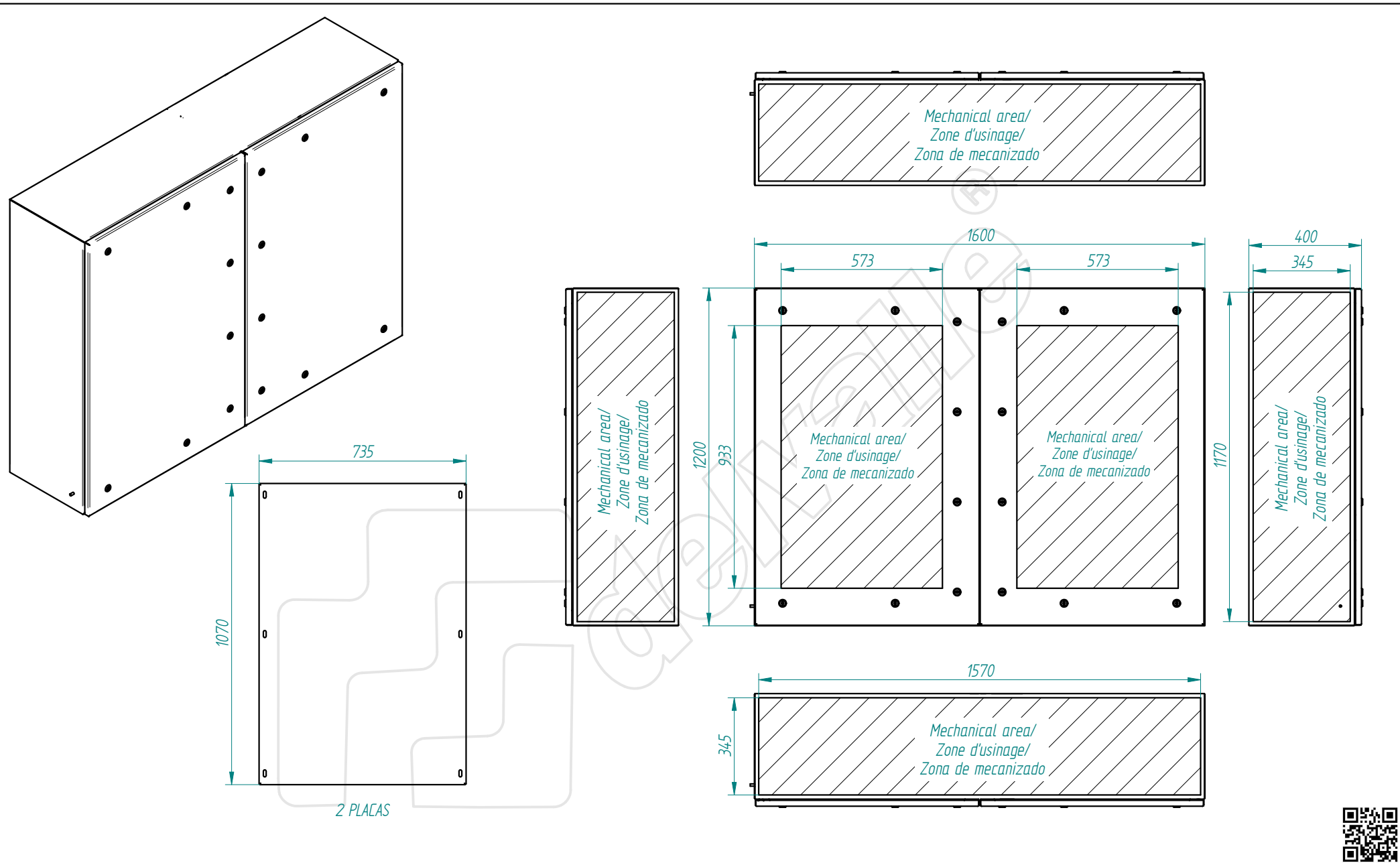

TOLERANCIA GENERAL DE MECANIZACION según DIN 7168					Referencia:	DIBUJADO:	FECHA:	FIRMA:	
						APROBADO:	28/03/2022	D.Martínez	
	Creación del documento	28/03/2022	D.MTNEZ	A	-	DESIGNACIÓN:			Nº PLANO:
	MODIFICACIONES	FECHA:	FIRMA:	REVISIÓN:	plegado: acabado:	tribex 2p-1200x1200x400-estandar			

This present document and its contents are confidential and are the exclusive intellectual and / or industrial property of DELVALLE. In addition to any technology, design, invention, work, process, know-how, calculation, manual, method, solution, idea, improvement, drawing, diagram, modification, combination and, in short, any associated information involving industrial or intellectual property developed or supplied by DELVALLE on the occasion of the quote, order execution or incorporated into the design or operation of the supply. The recipient may not use such property in his favour or in that of a third party for purposes other than the fulfilment of the order and the operation and maintenance of the supply, without the prior written consent of DELVALLE. It is strictly forbidden to totally or partially reproduce this document and to misuse it and / or to show it to third parties. The infringing parties shall be required to pay the corresponding compensation for damages, and any other legal or criminal responsible for the infringement may give rise to.



TOLERANCIA GENERAL DE MECANIZACION según DIN 7168					Referencia:		FECHA:	FIRMA:	
						DIBUJADO:	28/03/2022	D.Martínez	
						APROBADO:	28/03/2022	D.Martínez	
	Creación del documento	28/03/2022	D.MTNEZ	A	-	DESIGNACIÓN:			Nº PLANO:
	MODIFICACIONES	FECHA:	FIRMA:	REVISIÓN:	plegado: acabado:	tribex 2p-1200x1600x400-estandar			

This present document and its contents are confidential and are the exclusive intellectual and / or industrial property of DELVALLE. In addition to any technology, design, invention, work, process, know-how, calculation, manual, method, solution, idea, improvement, drawing, diagram, modification, combination and, in short, any associated information or documentation involving industrial or intellectual property developed or supplied by DELVALLE on the occasion of the quote, order execution or incorporated into the design or operation of the supply. The recipient may not use such property in his favour or in that of a third party for purposes other than the fulfilment of the order and the operation and maintenance of the supply, without the prior written consent of DELVALLE. It is strictly forbidden to totally or partially reproduce this document and to misuse it and / or to show it to third parties. The infringing parties shall be required to pay the corresponding compensation for damages, and any other legal or criminal responsible. The infringement may give rise to.

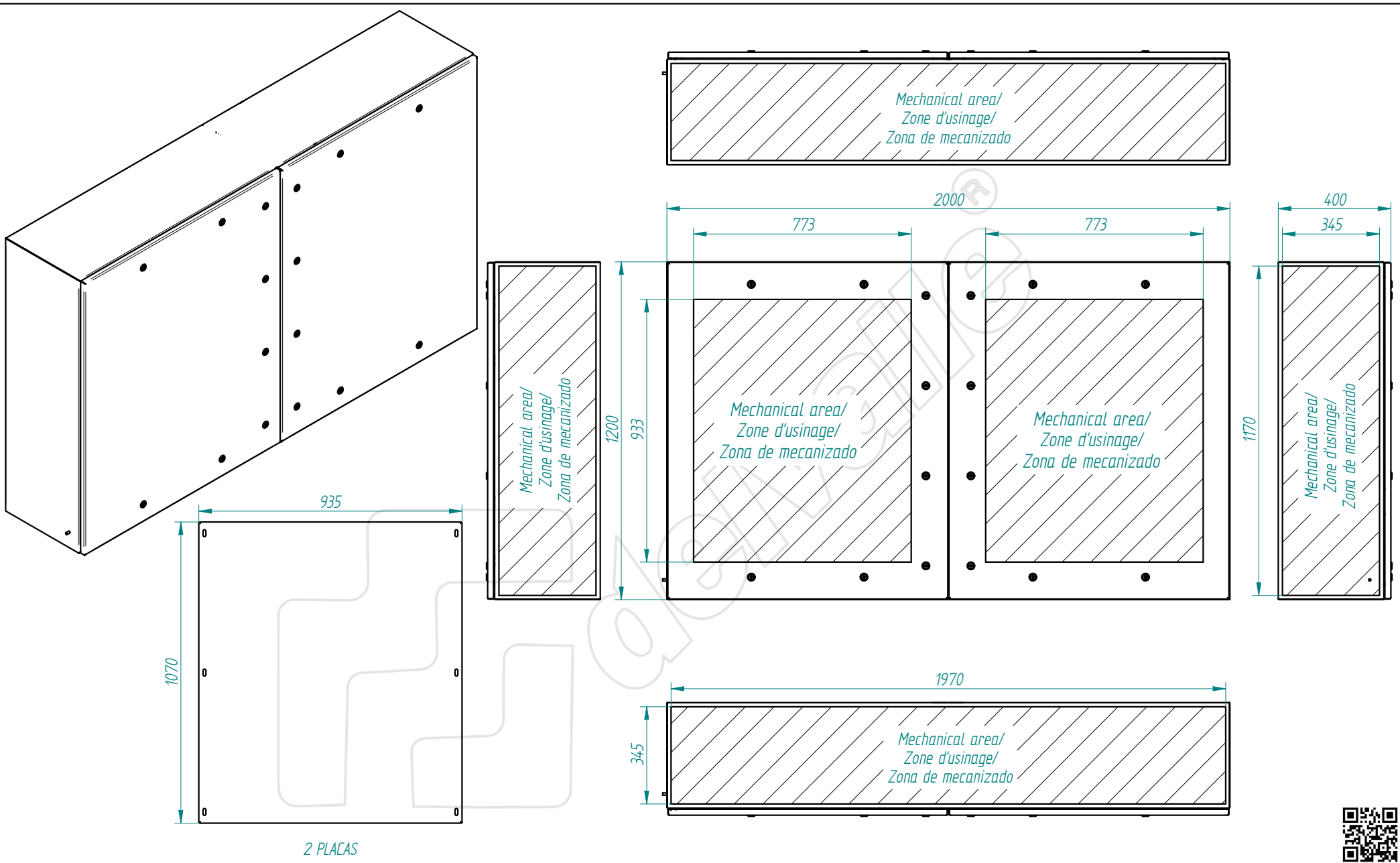

TOLERANCIA GENERAL DE MECANIZACION según DIN 7168	Creación del documento	28/03/2022	D.MTNEZ	A	Referencia: - plegado: acabado.	DIBUJADO:	28/03/2022	FIRMA:	D.Martínez	 Nº PLANO:
	MODIFICACIONES	FECHA:	FIRMA:	REVISIÓN:		APROBADO:	28/03/2022	D.Martínez	DESIGNACIÓN:	



This present document and its contents are confidential and are the exclusive intellectual and / or industrial property of DELVALLE. In addition to any technology, design, invention, work, process, know-how, calculation, manual, method, solution, idea, improvement, drawing, diagram, modification, combination and, in short, any associated information involving industrial or intellectual property developed or supplied by DELVALLE on the occasion of the quote, order execution or incorporated into the design or operation of the supply. The recipient may not use such property in his favour or in that of a third party for purposes other than the fulfilment of the order and the operation and maintenance of the supply, without the prior written consent of DELVALLE. It is strictly forbidden to totally or partially reproduce this document and to misuse it and / or to show it to third parties. The infringing parties shall be required to pay the corresponding compensation for damages and any other legal or criminal responsible. The infringement may give rise to.

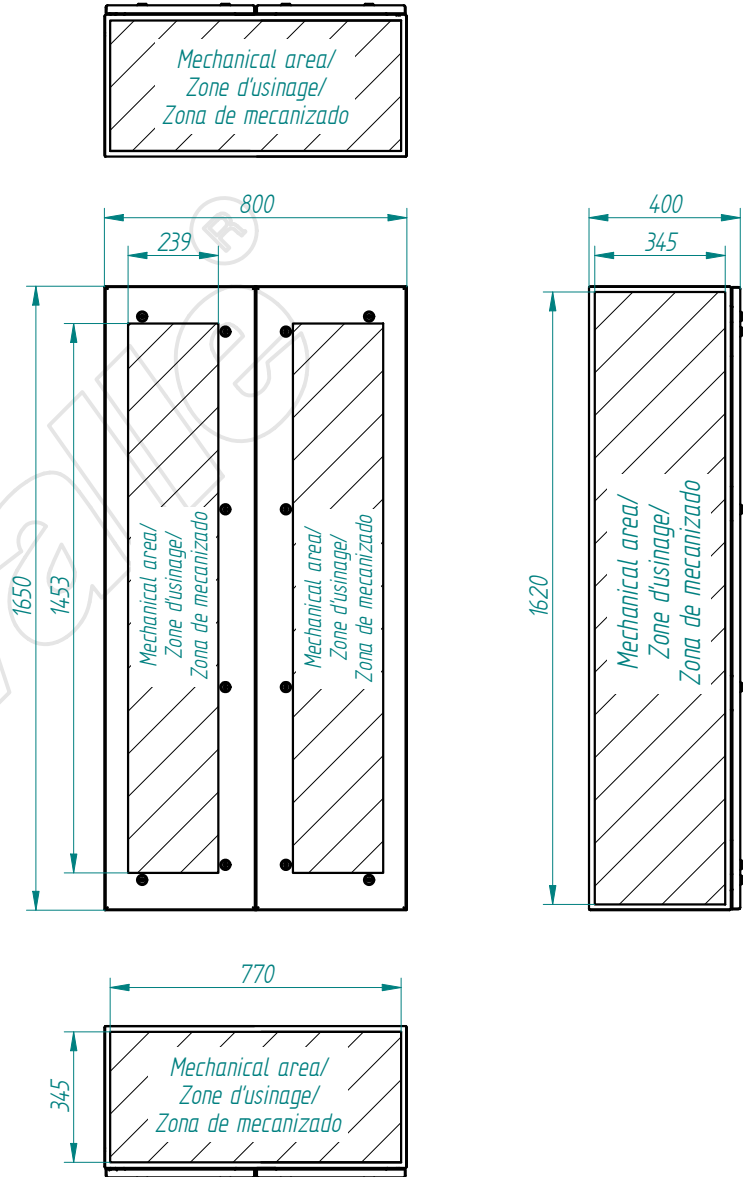
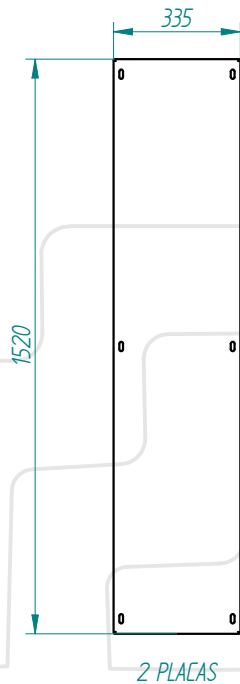
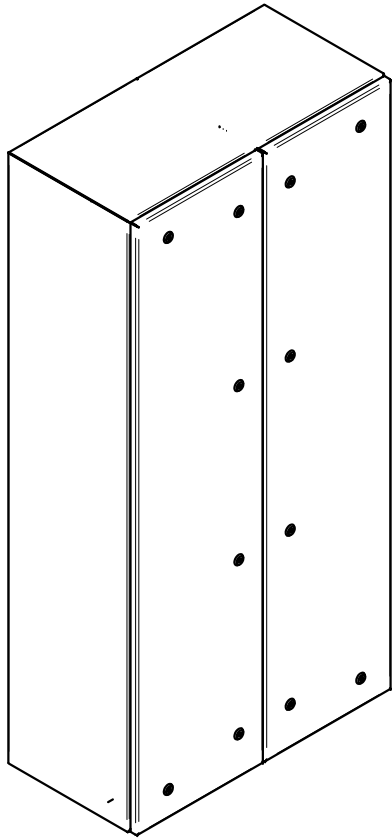

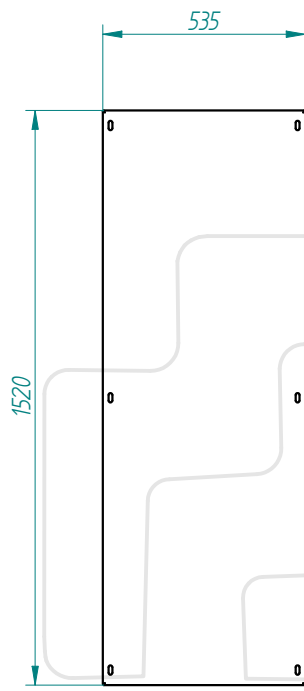
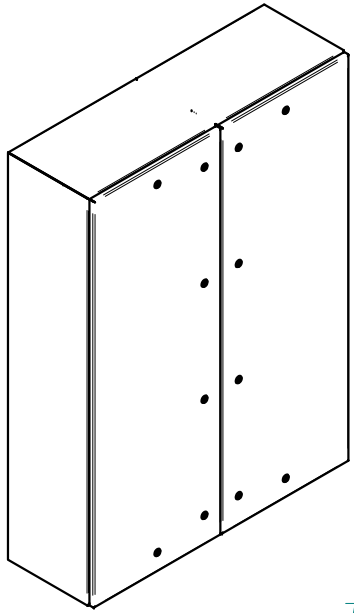

TOLERANCIA GENERAL DE MECANIZACION segun DIN 7168					Referencia:		FECHA:	FIRMA:	
							28/03/2022	D.Martinez	
	Creación del documento	28/03/2022	D.MTNEZ	A	-	DESIGNACIÓN:		D.Martinez	Nº PLANO:
	MODIFICACIONES	FECHA:	FIRMA:	REVISIÓN:	plegado: acabado:	tribex 2p-1650x800x400-estandar			

This present document and its contents are confidential and are the exclusive intellectual and / or industrial property of DELVALLE. In addition to any technology, design, invention, work, process, know-how, calculation, manual, method, solution, idea, improvement, drawing, diagram, modification, combination and, in short, any associated information involving industrial or intellectual property developed or supplied by DELVALLE on the occasion of the quote, order execution or incorporated into the design or operation of the supply. The recipient may not use such property in his favour or in that of a third party for purposes other than the fulfilment of the order and the operation and maintenance of the supply, without the prior written consent of DELVALLE. It is strictly forbidden to totally or partially reproduce this document and to misuse it and / or to show it to third parties. The infringing parties shall be required to pay the corresponding compensation for damages and any other legal or criminal responsible. The infringement may give rise to.

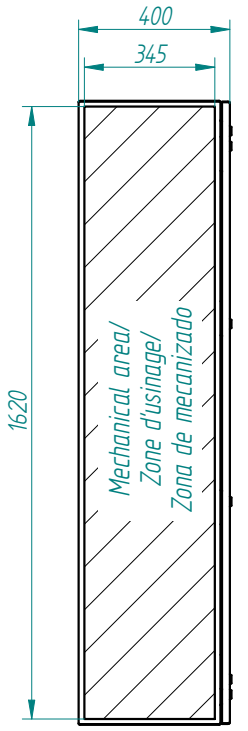
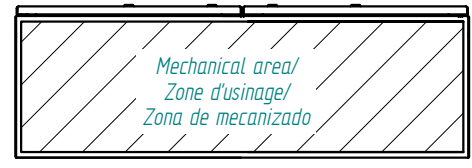
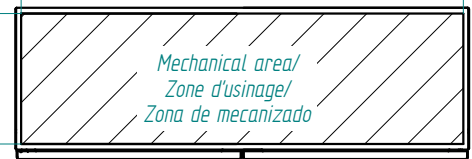
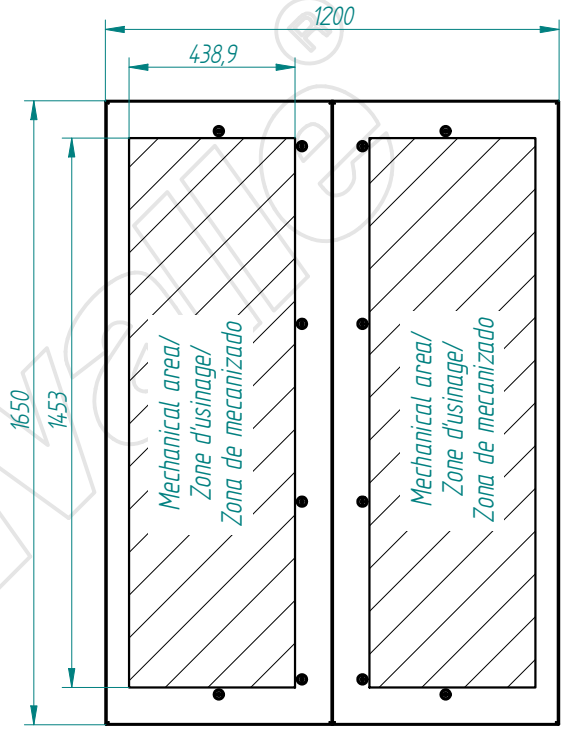

2 PLACAS



TOLERANCIA GENERAL DE MECANIZACION según DIN 7168	Creación del documento	01/04/2022	D.MTNEZ	A	Referencia: - plegado: acabado:	DIBUJADO:	01/04/2022	FIRMA:	D.Martínez	 Nº PLANO:
	MODIFICACIONES	FECHA:	FIRMA:	REVISIÓN:		APROBADO:	01/04/2022	D.Martínez		
	DESIGNACIÓN:						tribex 2p-1650x1200x400-estandar			

This present document and its contents are confidential and are the exclusive intellectual and / or industrial property of DELVALLE . In addition to any technology, design, invention, work, process, know-how, calculation, manual, method, solution, idea, improvement, drawing, diagram, modification, combination and, in short, any associated information involving industrial or intellectual property developed or supplied by DELVALLE on the occasion of the quote, order execution or incorporated into the design or operation of the supply. The recipient may not use such property in his favour or in that of a third party for purposes other than the fulfilment of the order and the operation and maintenance of the supply, without the prior written consent of DELVALLE. It is strictly forbidden to totally or partially reproduce this document and to misuse it and / or to show it to third parties. The infringing parties shall be required to pay the corresponding compensation for damages, and any other legal or criminal responsible for the infringement may give rise to.

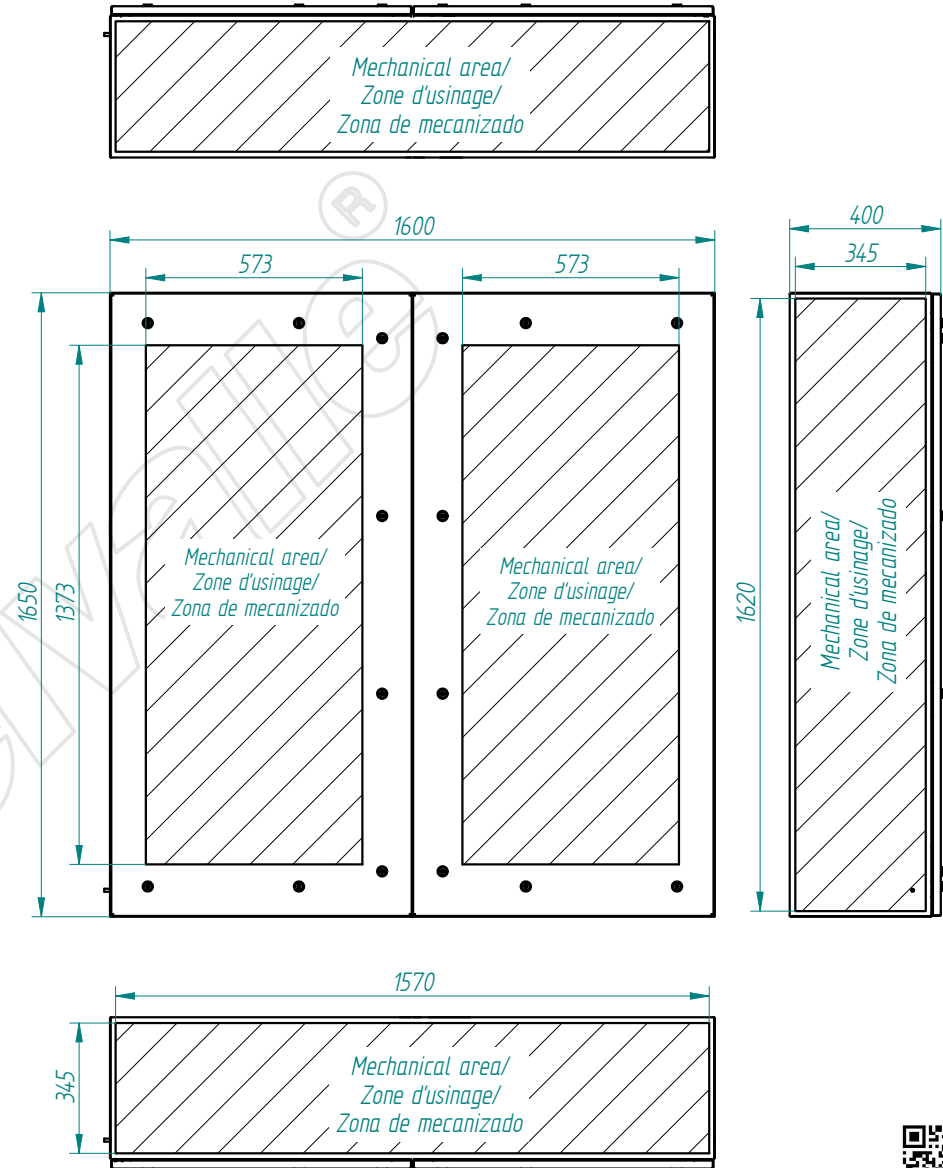
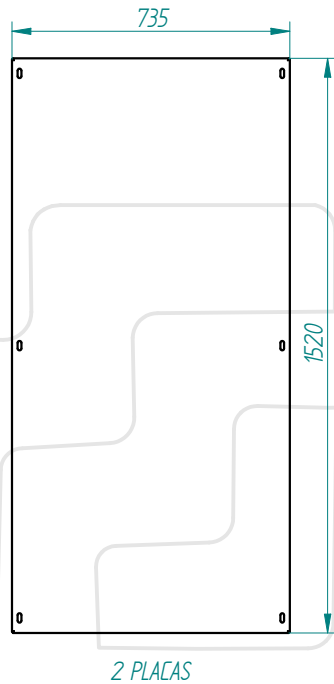
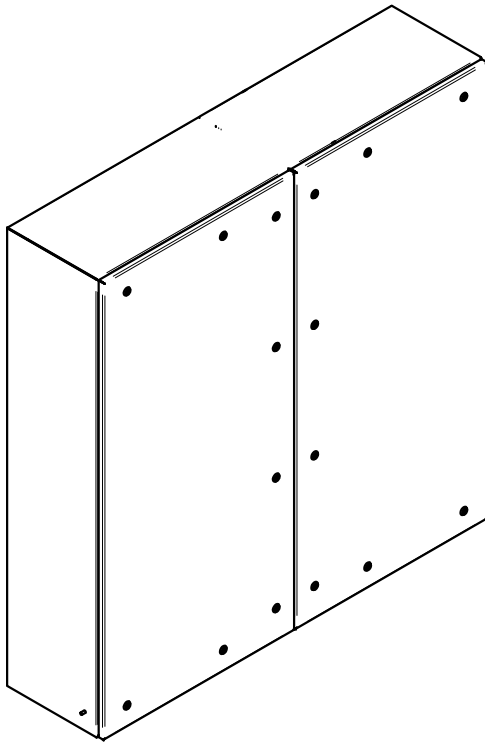

TOLERANCIA GENERAL DE MECANIZACION según DIN 7168

Creación del documento	28/03/2022	D.MTNEZ	A
MODIFICACIONES	FECHA:	FIRMA:	REVISIÓN:

Referencia:

DIBUJADO:	FECHA:	FIRMA:
APROBADO:	28/03/2022	D.Martinez
DESIGNACIÓN:		
tribex 2p-1650x1600x400-estandar		

Nº PLANO:



This present document and its contents are confidential and are the exclusive intellectual and / or industrial property of DELVALLE. In addition to any technology, design, invention, work, process, know-how, calculation, manual, method, solution, idea, improvement, drawing, diagram, modification, contribution and, in short, any associated information involving industrial or intellectual property developed or supplied by DELVALLE on the occasion of the quote, order execution or incorporated into the design or operation of the supply. The recipient may not use such property in his favour or in that of a third party for purposes other than the fulfilment of the order and the operation and maintenance of the supply, without the prior written consent of DELVALLE. It is strictly forbidden to totally or partially reproduce this document and to misuse it and / or to show it to third parties. The infringing parties shall be required to pay the corresponding compensation for damages, and any other legal or criminal, responsible for the infringement may give rise to.

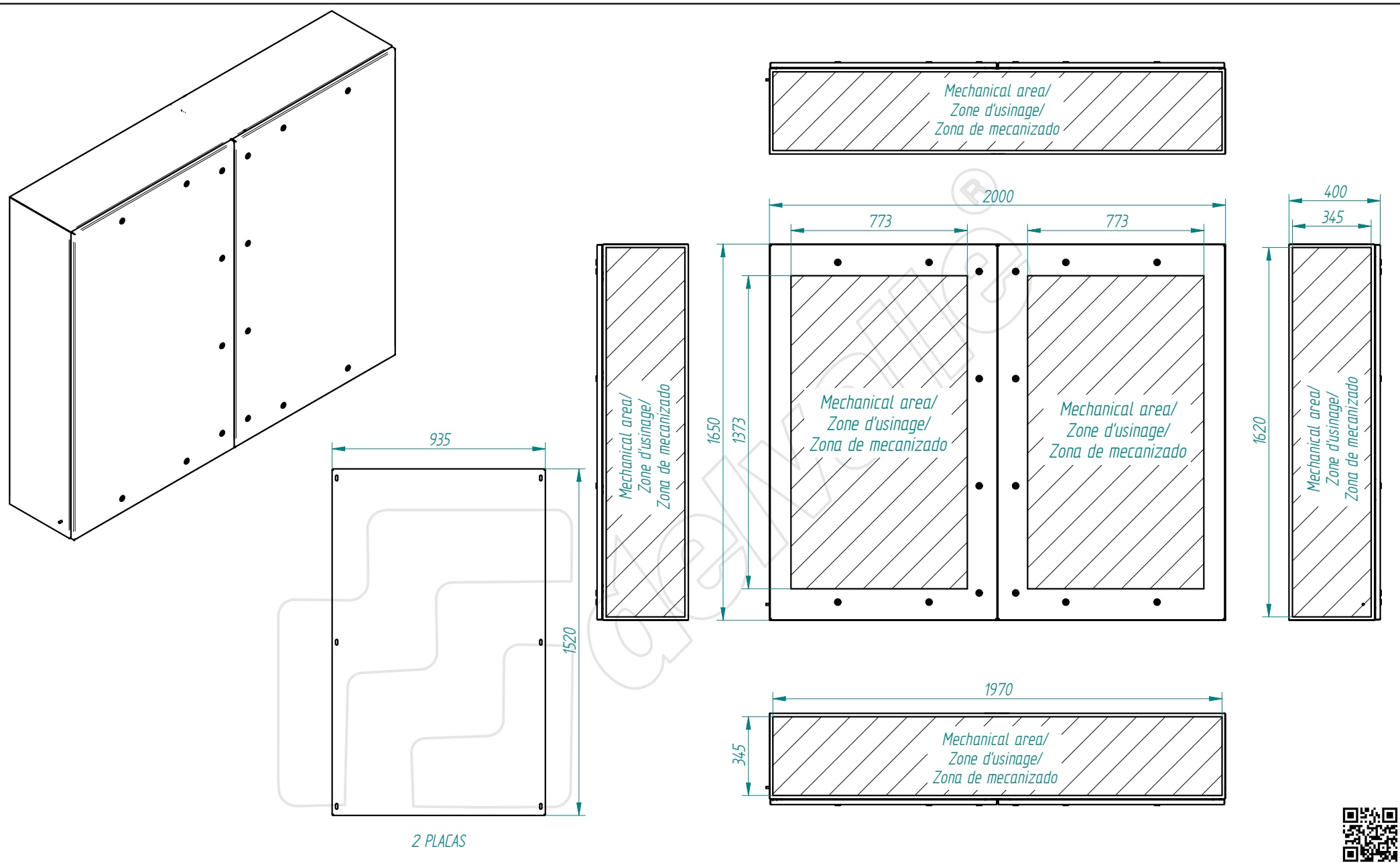

TOLERANCIA GENERAL DE MECANIZACION segun DIN 7168					Referencia: - plegado: acabado:	DIBUJADO:	FECHA:	FIRMA:	 Nº PLANO:
						28/03/2022	D.Martinez		
						28/03/2022	D.Martinez		
	Creación del documento	28/03/2022	D.MTNEZ	A		DESIGNACIÓN:			
	MODIFICACIONES	FECHA:	FIRMA:	REVISIÓN:		tribex 2p-1650x2000x400-estandar			

This present document and its contents are confidential and are the exclusive intellectual and / or industrial property of DELVALLE . In addition to any technology, design, invention, work, process, know-how, calculation, manual, method, solution, idea, improvement, drawing, diagram, modification, combination and, in short, any associated information involving industrial or intellectual property developed or supplied by DELVALLE on the occasion of the quote, order execution or incorporated into the design or operation of the supply. The recipient may not use such property in his favour or in that of a third party for purposes other than the fulfilment of the order and the operation and maintenance of the supply, without the prior written consent of DELVALLE. It is strictly forbidden to totally or partially reproduce this document and to misuse it and / or to show it to third parties. The infringing parties shall be required to pay the corresponding compensation for damages, and any other legal or criminal responsible for the infringement may give rise to.

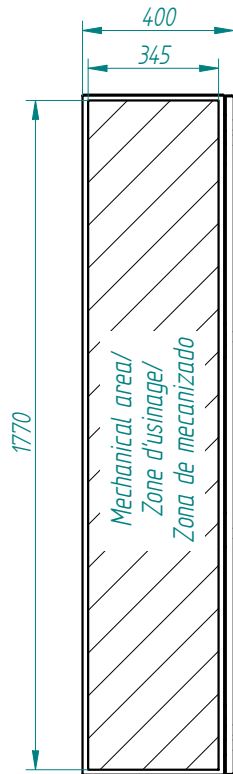
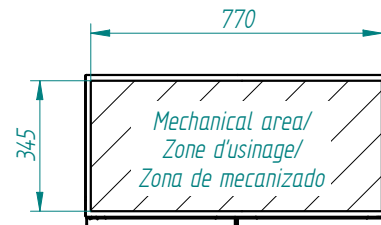
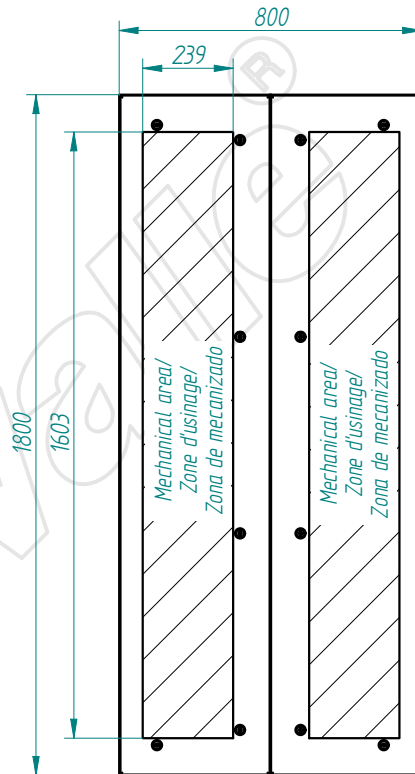
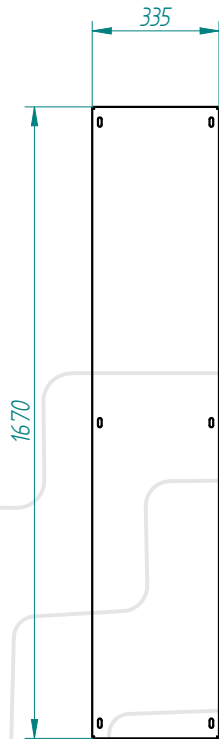
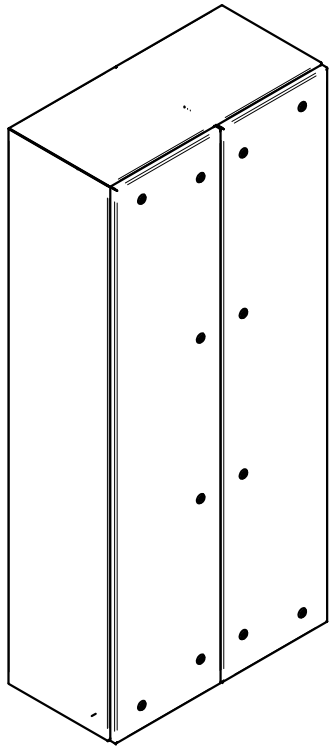

TOLERANCIA GENERAL DE MECANIZACION según DIN 7168

Creación del documento	28/03/2022	D.MTNEZ	A
MODIFICACIONES	FECHA:	FIRMA:	REVISIÓN:

Referencia:

DIBUJADO:	FECHA:	FIRMA:
APROBADO:	28/03/2022	D.Martinez
DESIGNACIÓN:		
tribex 2p-1800x800x400-estandar		

Nº PLANO:



This present document and its contents are confidential, and are the exclusive intellectual and / or industrial property of DELVALLE. In addition to any technology, design, invention, work, process, know-how, calculation, manual, method, solution, idea, improvement, drawing, diagram, modification, combination and, in short, any associated information involving industrial or intellectual property developed or supplied by DELVALLE on the occasion of the quote, order execution or incorporated into the design or operation of the supply. The recipient may not use such property in his favour or in that of a third party for purposes other than the fulfilment of the order and the operation and maintenance of the supply, without the prior written consent of DELVALLE. It is strictly forbidden to totally or partially reproduce this document and to misuse it and / or to show it to third parties. The infringing parties shall be required to pay the corresponding compensation for damages, and any other legal or criminal responsibility. The infringement may give rise to.

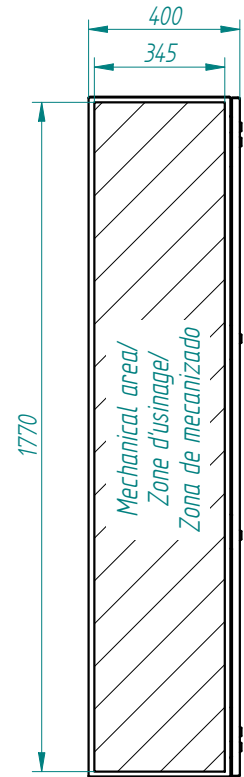
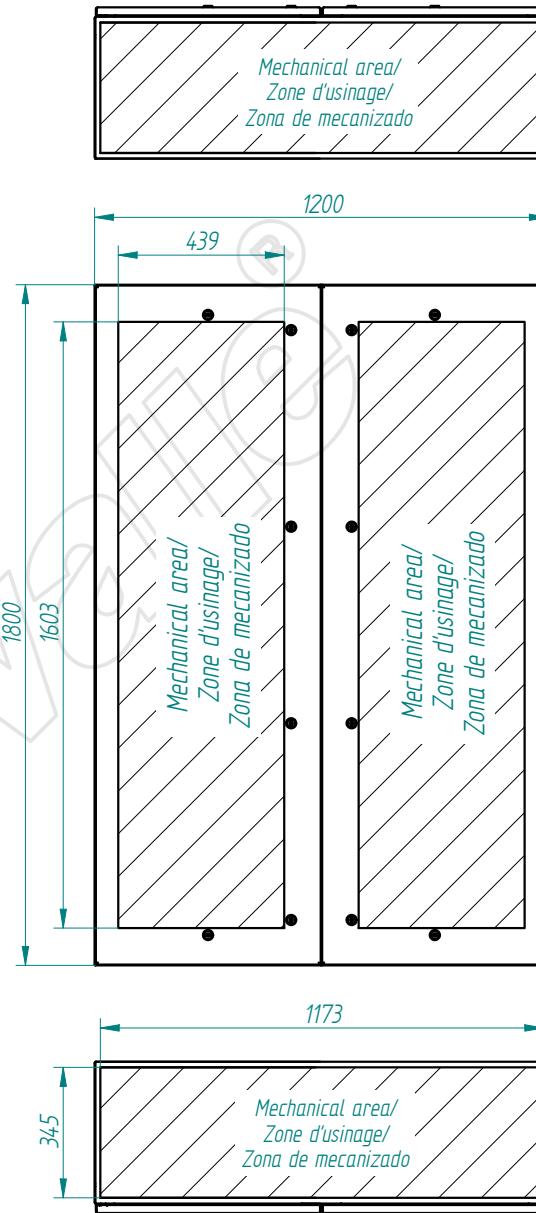
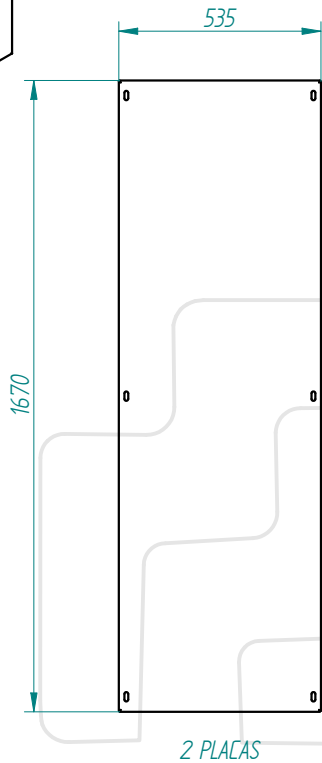
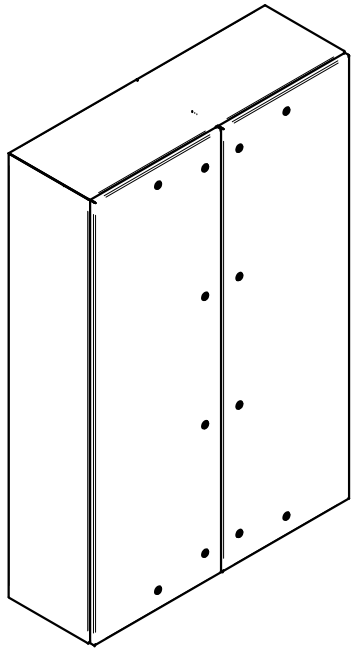

TOLERANCIA GENERAL DE MECANIZACION según DIN 7168					Referencia:		FECHA:	FIRMA:	 Nº PLANO:
						DIBUJADO:	28/03/2022	D.Martínez	
						APROBADO:	28/03/2022	D.Martínez	
	Creación del documento	28/03/2022	D.MTNEZ	A	-	DESIGNACIÓN:			
	MODIFICACIONES	FECHA:	FIRMA:	REVISIÓN:	plegado: acabado:	tribex 2p-1800x1200x400-estandar			

This present document and its contents are confidential, and are the exclusive intellectual and / or industrial property of DELVALLE . In addition to any technology, design, invention, work, process, know-how, calculation, manual, method, solution, idea, improvement, drawing, diagram, modification, combination and, in short, any associated information involving industrial or intellectual property developed or supplied by DELVALLE on the occasion of the quote, order execution or incorporated into the design or operation of the supply. The recipient may not use such property in his favour or in that of a third party for purposes other than the fulfilment of the order and the operation and maintenance of the supply, without the prior written consent of DELVALLE. It is strictly forbidden to totally or partially reproduce this document and to misuse it and / or to show it to third parties. The infringing parties shall be required to pay the corresponding compensation for damages, and any other legal or criminal responsible for the infringement may give rise to.

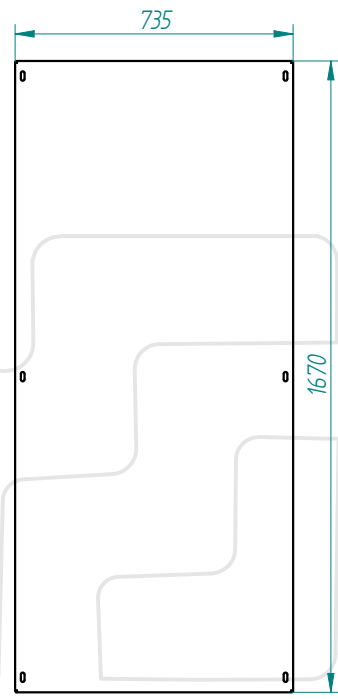
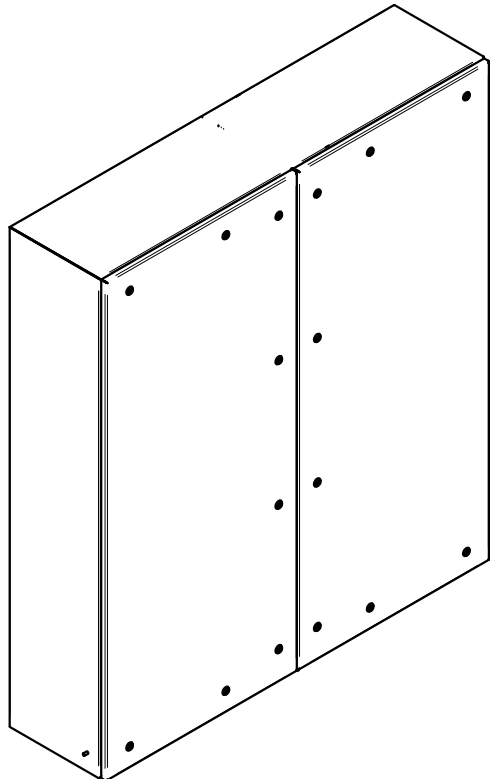

2 PLACAS

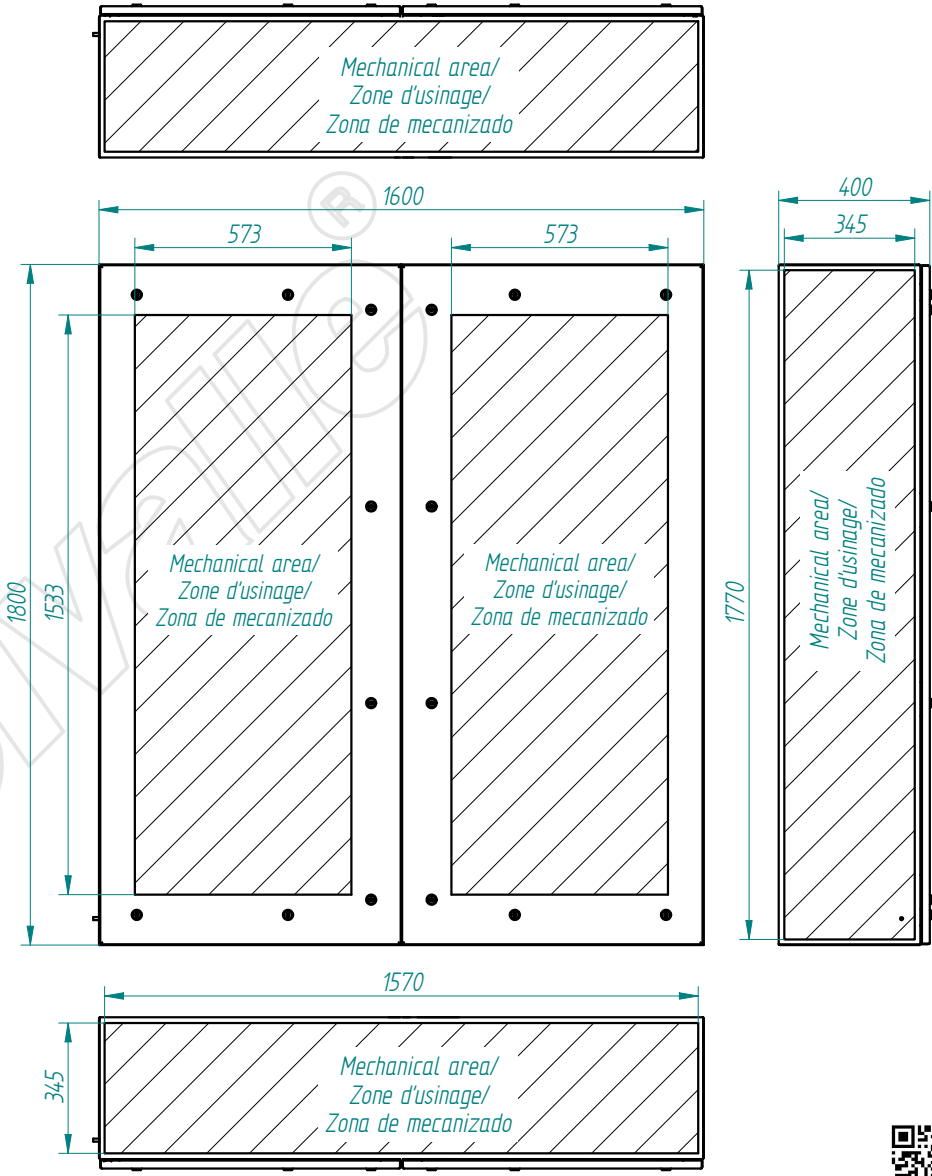

TOLERANCIA GENERAL DE MECANIZACION según DIN 7168					Referencia:			
						DIBUJADO:	FECHA:	FIRMA:
						28/03/2022	28/03/2022	D.Martinez
	Creación del documento	28/03/2022	D.MTNEZ	A	-	APROBADO:		D.Martinez
	MODIFICACIONES	FECHA:	FIRMA:	REVISIÓN:	plegado: acabado:	DESIGNACIÓN:		Nº PLANO:
						tribex 2p-1800x1600x400-estandar		



This present document and its contents are confidential and are the exclusive intellectual and / or industrial property of DELVALLE. In addition to any technology, design, invention, work, process, know-how, calculation, manual, method, solution, idea, improvement, drawing, diagram, modification, combination and, in short, any associated information involving industrial or intellectual property developed or supplied by DELVALLE on the occasion of the quote, order execution or incorporated into the design or operation of the supply. The recipient may not use such property in his favour or in that of a third party for purposes other than the fulfilment of the order and the operation and maintenance of the supply, without the prior written consent of DELVALLE. It is strictly forbidden to totally or partially reproduce this document and to misuse it and / or to show it to third parties. The infringing parties shall be required to pay the corresponding compensation for damages and any other legal or criminal responsible. The infringement may give rise to.

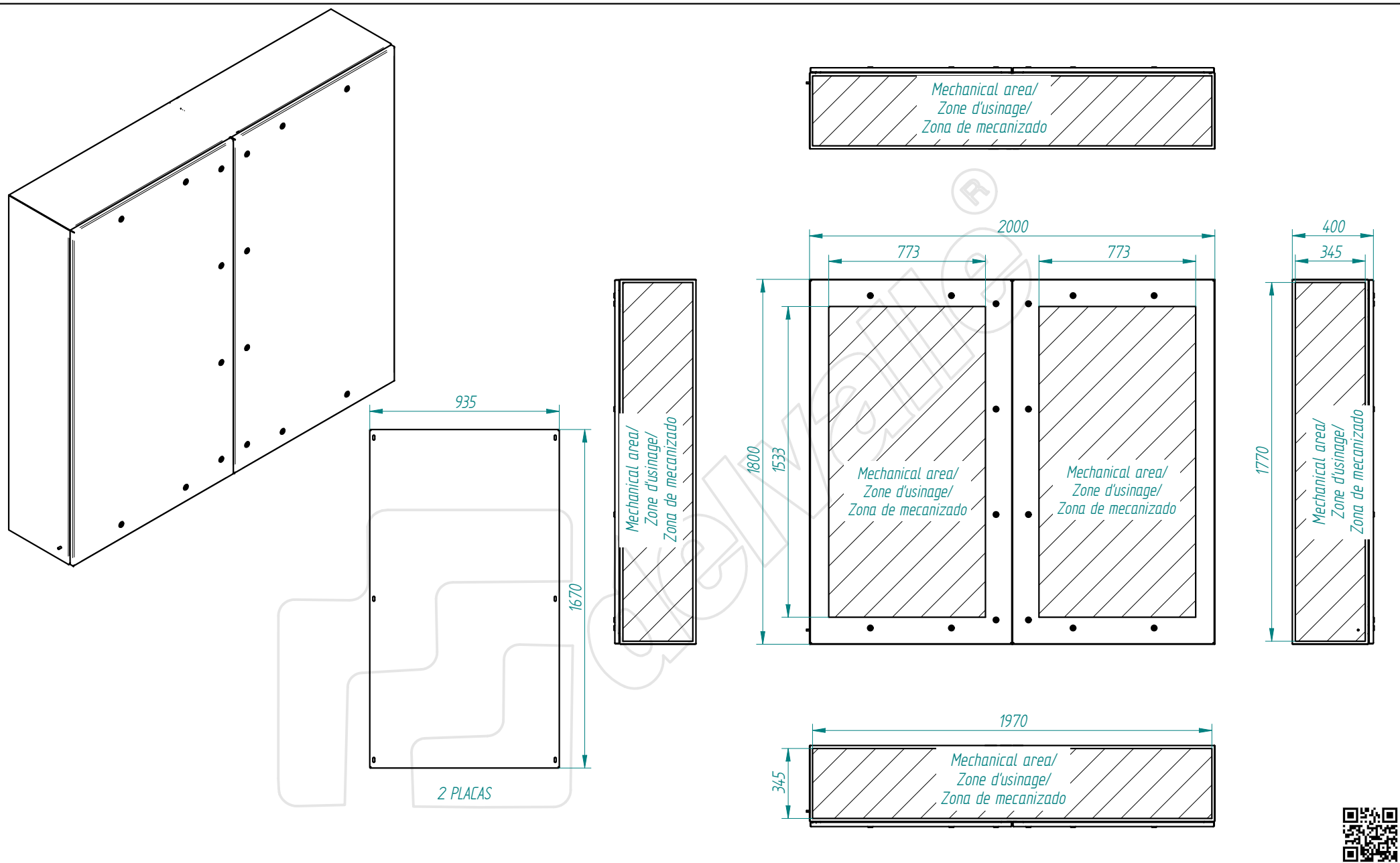

TOLERANCIA GENERAL DE MECANIZACION según DIN 7168					Referencia:				
	Creación del documento	28/03/2022	D.MTNEZ	A		DIBUJADO:	28/03/2022	D.Martínez	
	MODIFICACIONES	FECHA:	FIRMA:	REVISIÓN:		APROBADO:	28/03/2022	D.Martínez	
					- plegado: acabado:	DESIGNACIÓN:	tribex 2p-1800x2000x400-estandar		
								Nº PLANO:	



This present document and its contents are confidential and are the exclusive intellectual and / or industrial property of DELVALLE . In addition to any technology, design, invention, work, process, know-how, calculation, manual, method, solution, idea, improvement, drawing, diagram, modification, contribution and, in short, any associated information involving industrial or intellectual property developed or supplied by DELVALLE on the occasion of the quote, order execution or incorporated into the design or operation of the supply. The recipient may not use such property in his favour or in that of a third party for purposes other than the fulfilment of the order and the operation and maintenance of the supply, without the prior written consent of DELVALLE. It is strictly forbidden to totally or partially reproduce this document and to misuse it and / or to show it to third parties. The infringing parties shall be required to pay the corresponding compensation for damages, and any other legal or criminal, responsible and the infringement may give rise to.

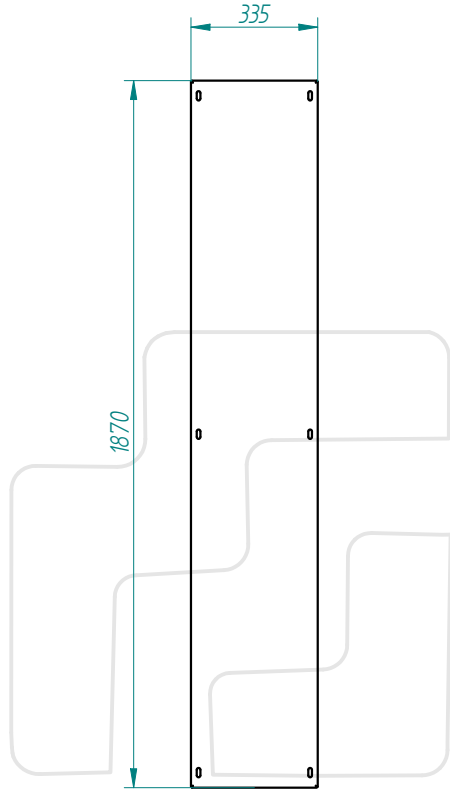
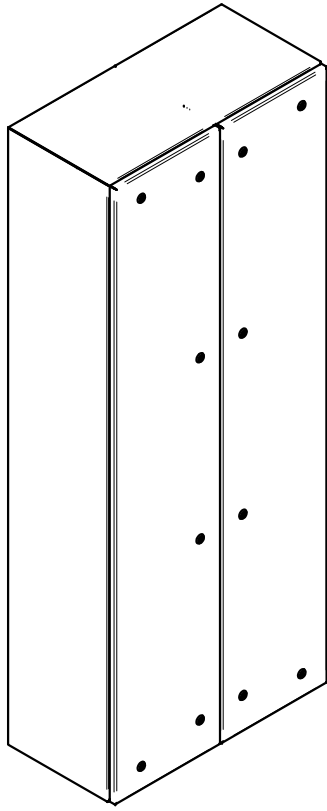

2 PLACAS

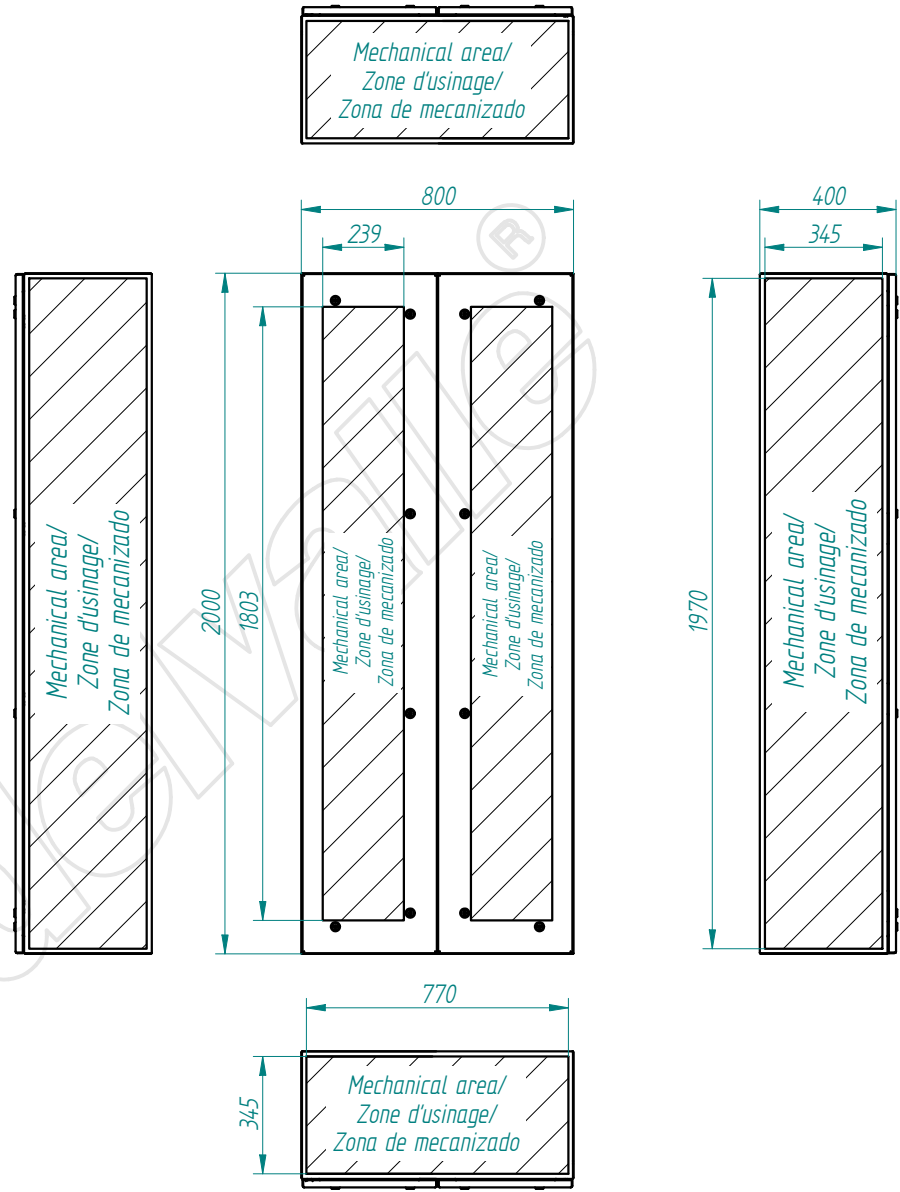

TOLERANCIA GENERAL DE MECANIZACION según DIN 7168	Creación del documento	28/03/2022	D.MTNEZ	A	-
	MODIFICACIONES	FECHA:	FIRMA:	REVISIÓN:	plegado: acabado:

Referencia:	DIBUJADO:	FECHA:	FIRMA:
	APROBADO:	28/03/2022	D.Martinez
DESIGNACIÓN:			Nº PLANO:
tribex 2p-2000x800x400-estandar			



This present document and its contents are confidential and are the exclusive intellectual and / or industrial property of DELVALLE . In addition to any technology, design, invention, work, process, know-how, calculation, manual, method, solution, idea, improvement, drawing, diagram, modification, combination and, in short, any associated information involving industrial or intellectual property developed or supplied by DELVALLE on the occasion of the quote, order execution or incorporated into the design or operation of the supply. The recipient may not use such property in his favour or in that of a third party for purposes other than the fulfilment of the order and the operation and maintenance of the supply, without the prior written consent of DELVALLE. It is strictly forbidden to totally or partially reproduce this document and to misuse it and / or to show it to third parties. The infringing parties shall be required to pay the corresponding compensation for damages, and any other legal or criminal responsible. The infringement may give rise to.

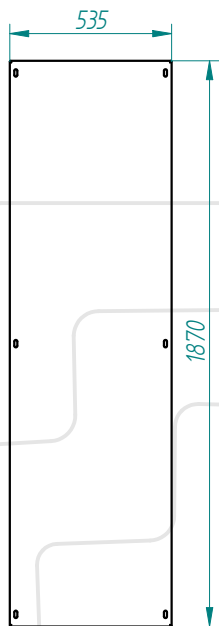
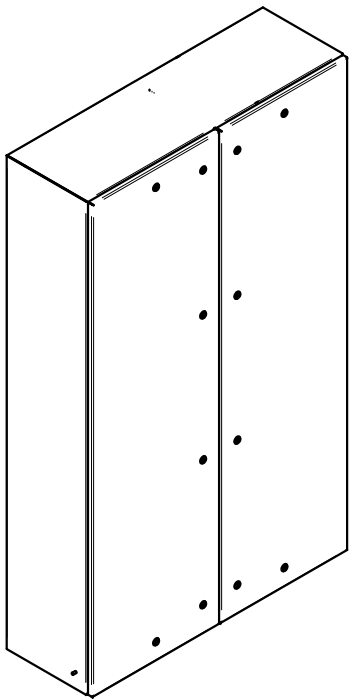

2 PLACAS

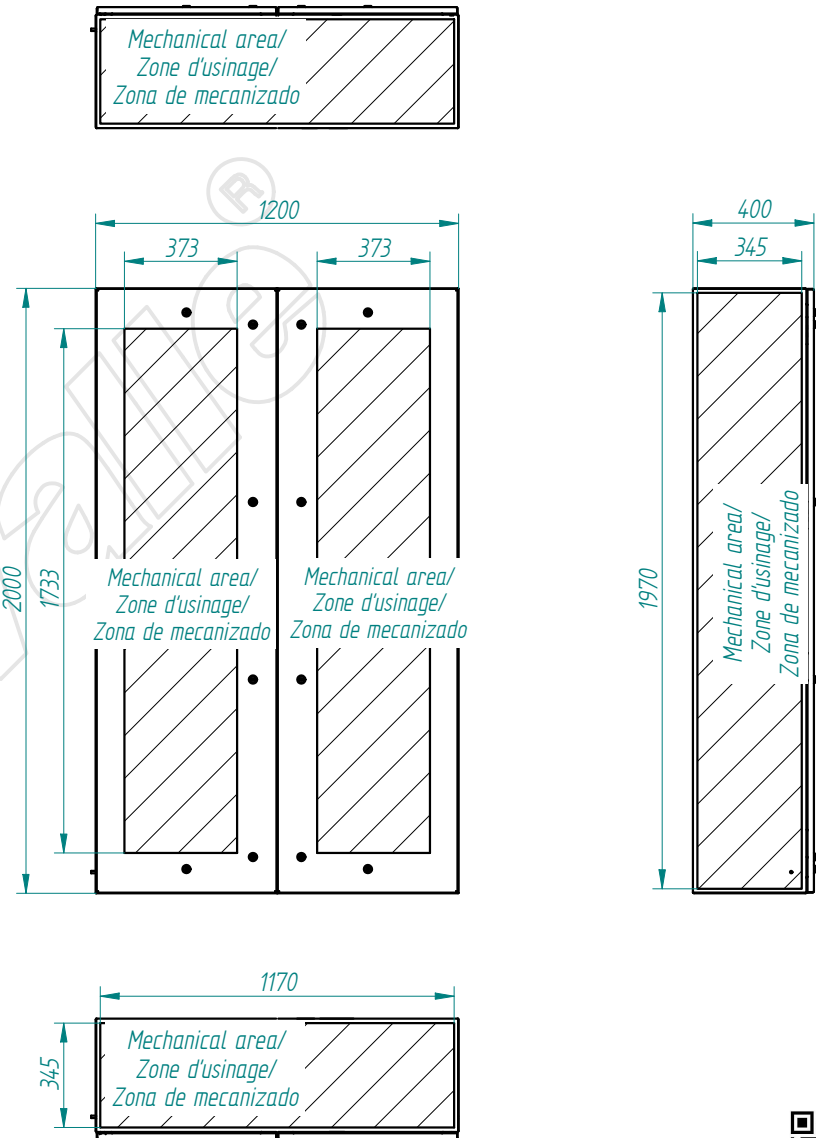

TOLERANCIA GENERAL DE MECANIZACION según DIN 7168					Referencia:		FECHA:	FIRMA:	
						DIBUJADO:	29/03/2022	D.Martínez	
						APROBADO:	29/03/2022	D.Martínez	
	Creación del documento	29/03/2022	D.MTNEZ	A	-	DESIGNACIÓN:			Nº PLANO:
	MODIFICACIONES	FECHA:	FIRMA:	REVISIÓN:	plegado: acabado:	tribex 2p-2000x1200x400-estandar			



This present document and its contents are confidential, and are the exclusive intellectual and / or industrial property of DELVALLE. In addition to any technology, design, invention, work, process, know-how, calculation, manual, method, solution, idea, improvement, drawing, diagram, modification, combination and, in short, any associated information involving industrial or intellectual property developed or supplied by DELVALLE on the occasion of the quote, order execution or incorporated into the design or operation of the supply. The recipient may not use such property in his favour or in that of a third party for purposes other than the fulfilment of the order and the operation and maintenance of the supply, without the prior written consent of DELVALLE. It is strictly forbidden to totally or partially reproduce this document and to misuse it and / or to show it to third parties. The infringing parties shall be required to pay the corresponding compensation for damages, and any other legal or criminal responsible. The infringement may give rise to.

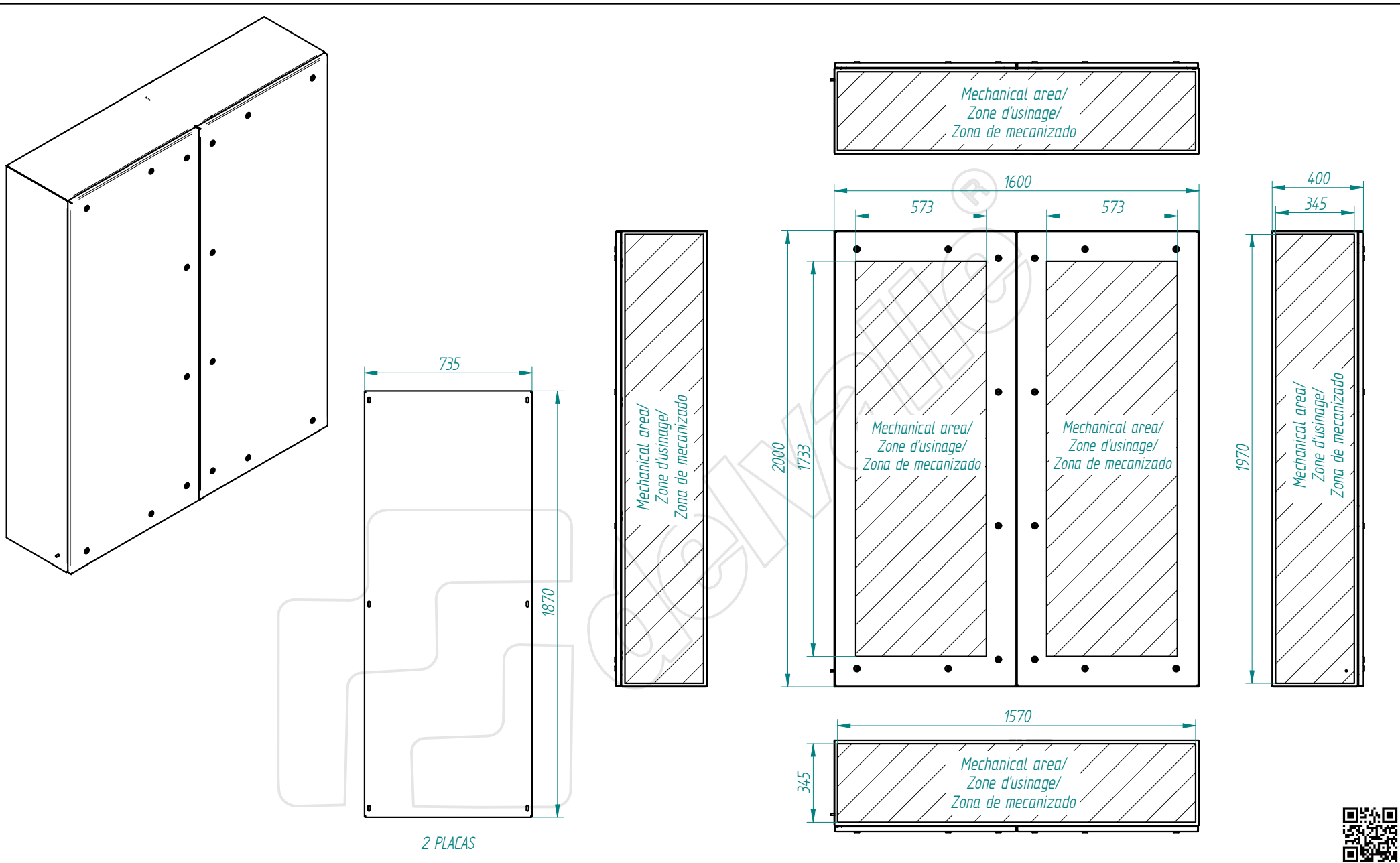

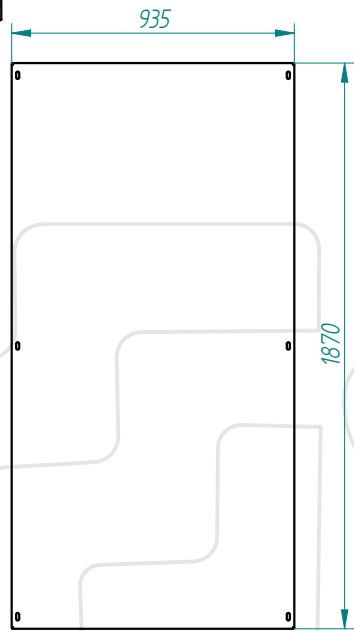
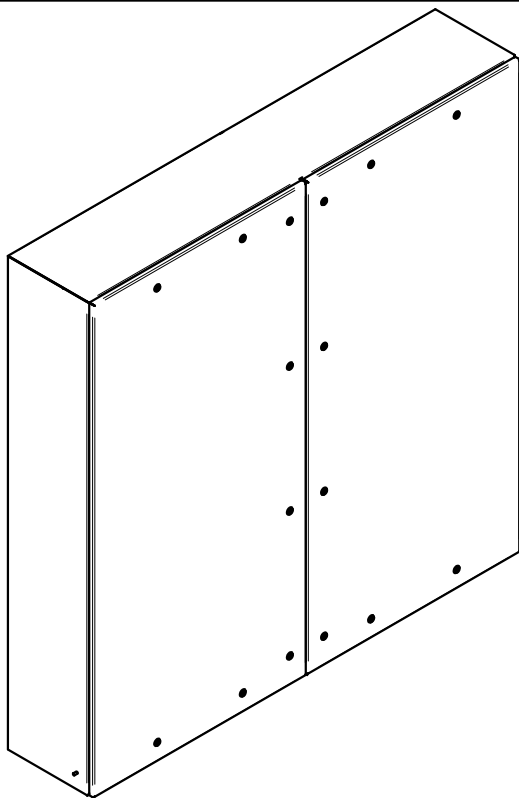

TOLERANCIA GENERAL DE MECANIZACION segun DIN 7168	Creación del documento	28/03/2022	D.MTNEZ	A	Referencia: - plegado: - acabado:	DIBUJADO:	28/03/2022	FIRMA:	D.Martinez	 Nº PLANO:
	MODIFICACIONES	FECHA:	FIRMA:	REVISIÓN:		APROBADO:	28/03/2022	D.Martinez		
	DESIGNACIÓN: tribex 2p-2000x1600x400-estandar									

This present document and its contents are confidential and are the exclusive intellectual and / or industrial property of DELVALLE . In addition to any technology, design, invention, work, process, know-how, calculation, manual, method, solution, idea, improvement, drawing, diagram, modification, combination and, in short, any associated information involving industrial or intellectual property developed or supplied by DELVALLE on the occasion of the quote, order execution or incorporated into the design or operation of the supply. The recipient may not use such property in his favour or in that of a third party for purposes other than the fulfilment of the order and the operation and maintenance of the supply, without the prior written consent of DELVALLE. It is strictly forbidden to totally or partially reproduce this document and to misuse it and / or to show it to third parties. The infringing parties shall be required to pay the corresponding compensation for damages and any other legal or criminal responsible. The infringement may give rise to.

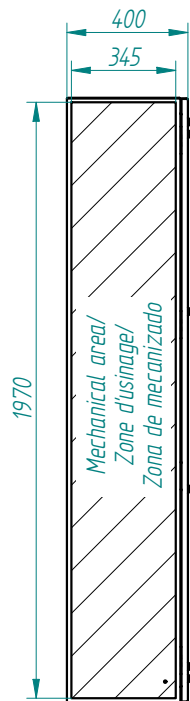
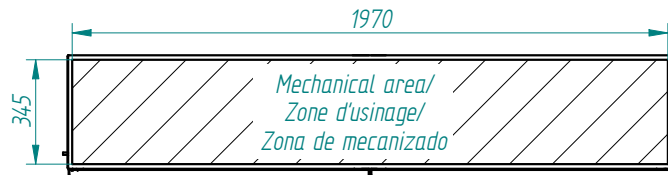
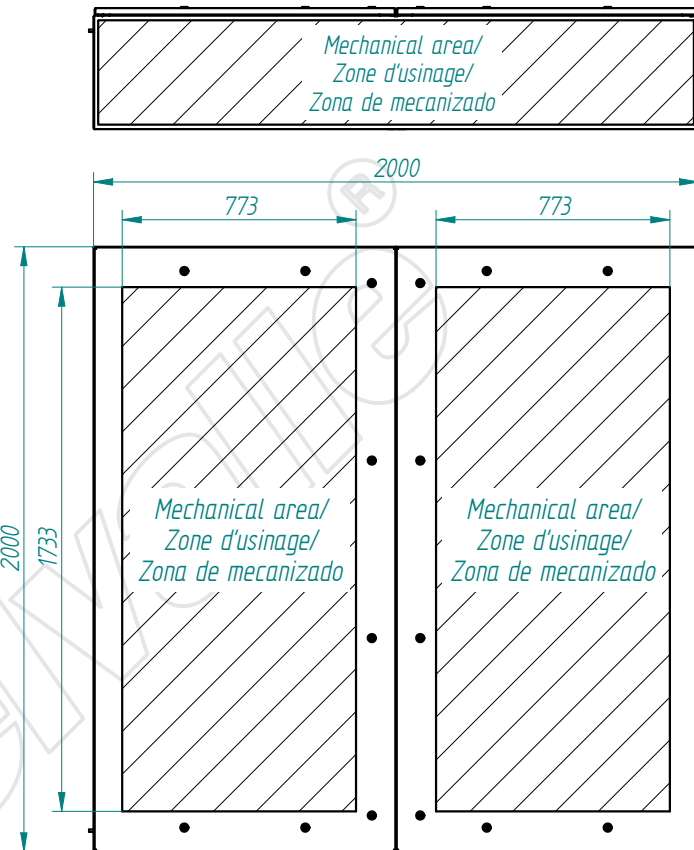

2 PLACAS



TOLERANCIA GENERAL DE MECANIZACION según DIN 7168					Referencia:		FECHA:	FIRMA:	
						DIBUJADO:	28/03/2022	D.Martínez	
						APROBADO:	28/03/2022	D.Martínez	
	Creación del documento	28/03/2022	D.MTNEZ	A	-	DESIGNACIÓN:			Nº PLANO:
	MODIFICACIONES	FECHA:	FIRMA:	REVISIÓN:	plegado: acabado:	tribex 2p-2000x2000x400-estandar			

