

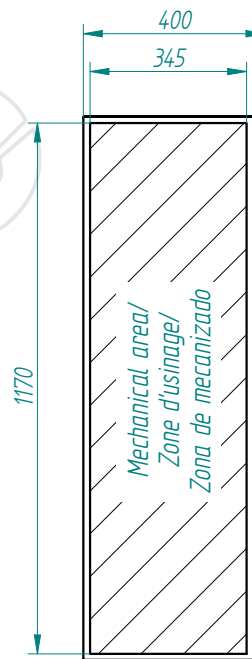

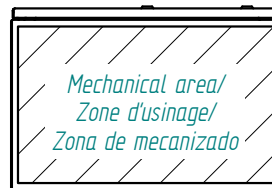

This present document and its contents are confidential, and are the exclusive intellectual and / or industrial property of DEVALLE. In addition to any technology, design, invention, work, process, know-how, calculation, manual, method, solution, idea, improvement, drawing, diagram, modification, contribution and, in short, any associated information or documentation involving industrial or intellectual property developed or supplied by DEVALLE on the occasion of the quote, order execution or incorporated into the design or operation of the supply. The recipient may not use such property in his favour or in that of a third party for purposes other than the fulfilment of the order and the operation and maintenance of the supply, without the prior written consent of DEVALLE. It is strictly forbidden to totally or partially reproduce this document and to misuse it and / or to show it to third parties. The infringing parties shall be required to pay the corresponding compensation for damages, and any other legal or criminal responsibility if the infringement may give rise to.

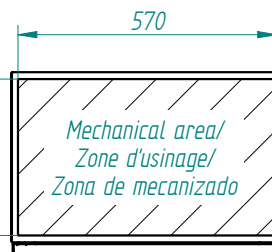
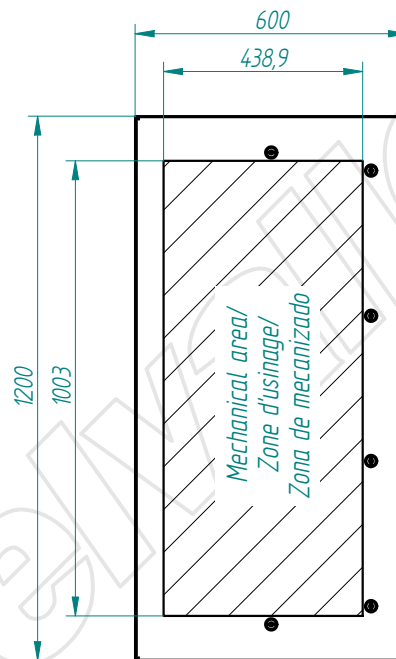
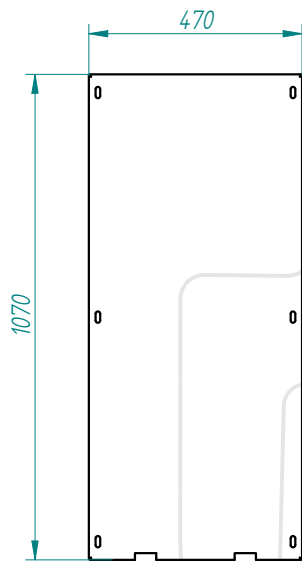
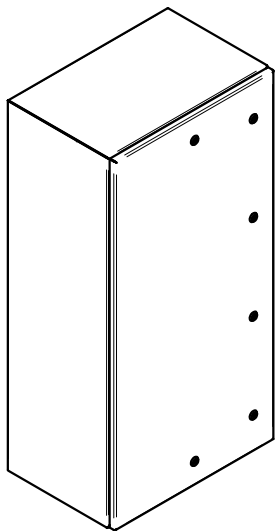

TOLERANCIA GENERAL DE MECANIZACION segun DIN 7168					Referencia:		FECHA:	FIRMA:	
						DIBUJADO:	27/04/2015	D.Martinez	
							APROBADO:	27/04/2015	D.Martinez
	Creación del documento	27/04/2015	D.MTNEZ	A	-	DESIGNACIÓN:			
	MODIFICACIONES	FECHA:	FIRMA:	REVISIÓN:	plegado: acabado:	tribex-1200x600x400-estandar			

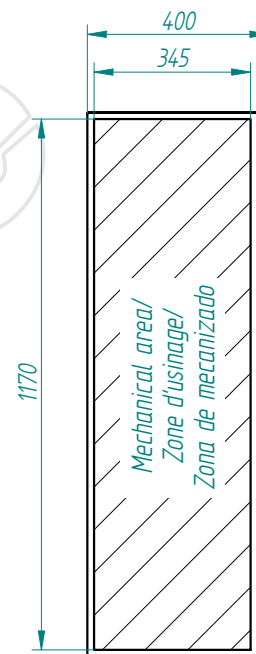
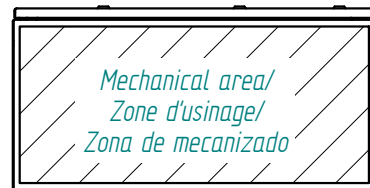
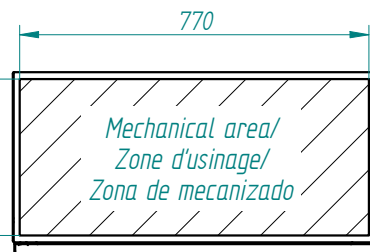
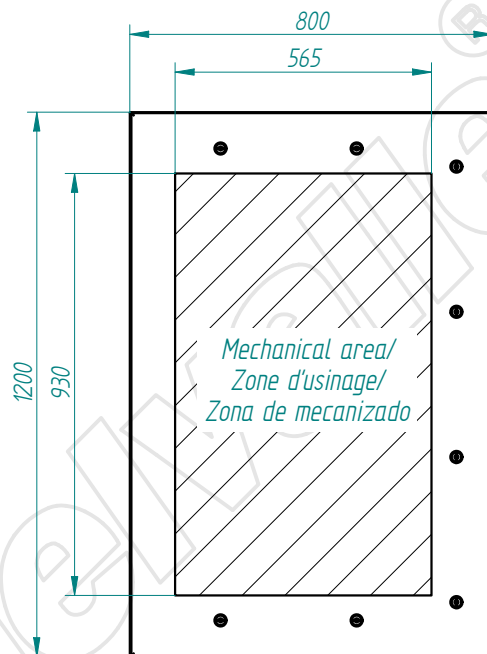
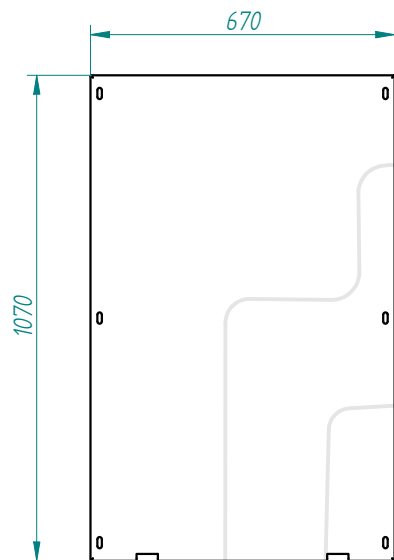
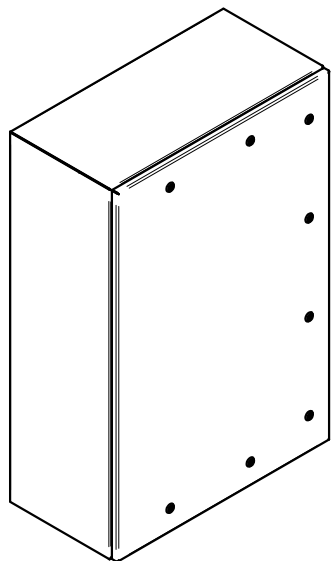
This present document and its contents are confidential, and are the exclusive intellectual and / or industrial property of DELVALLE. In addition to any technology, design, invention, work, process, know-how, calculation, manual, method, solution, idea, improvement, drawing, diagram, modification, contribution and, in short, any associated information or documentation involving industrial or intellectual property developed or supplied by DELVALLE on the occasion of the quote, order execution or incorporated into the design or operation of the supply. The recipient may not use such property in his favour or in that of a third party for purposes other than the fulfilment of the order and the operation and maintenance of the supply, without the prior written consent of DELVALLE. It is strictly forbidden to totally or partially reproduce this document and to misuse it and / or to show it to third parties. The infringing parties shall be required to pay the corresponding compensation for damages and any other legal or criminal responsibilities. The infringement may give rise to.



TOLERANCIA GENERAL DE MECANIZACION segun DIN 7168					Referencia: - plegado: - acabado:	DIBUJADO:	FECHA:	FIRMA:	 Nº PLANO:
						APROBADO:	27/04/2015	D.Martinez	
	Creación del documento	27/04/2015	D.MTNEZ	A		DESIGNACIÓN:	27/04/2015	D.Martinez	
	MODIFICACIONES	FECHA:	FIRMA:	REVISIÓN:		tribex -1200x800x400-estandar			

This present document and its contents are confidential, and are the exclusive intellectual and / or industrial property of DELVALLE. In addition to any technology, design, invention, work, process, know-how, calculation, manual, method, solution, drawing, improvement, diagram, modification, contribution and, in short, any associated information or documentation involving industrial or intellectual property developed or supplied by DELVALLE on the occasion of the quote, order execution or incorporated into the design or operation of the supply. The recipient may not use such property in his favour or in that of a third party for purposes other than the fulfilment of the order and the operation and maintenance of the supply, without the prior written consent of DELVALLE. It is strictly forbidden to totally or partially reproduce this document and to misuse it and / or to show it to third parties. The infringing parties shall be required to pay the corresponding compensation for damages, and any other legal or criminal responsibilities, the infringement may give rise to.

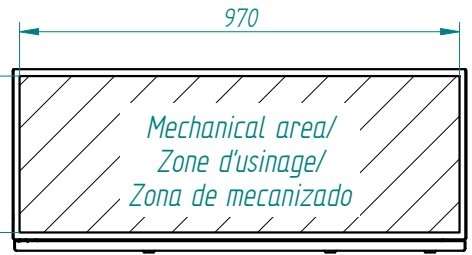
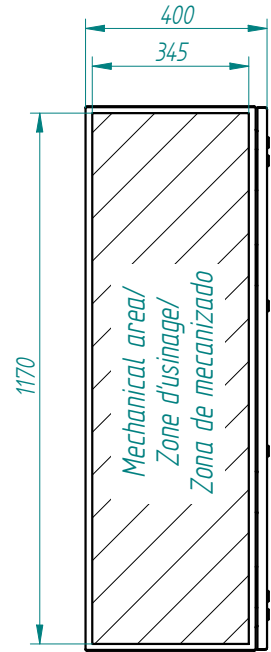
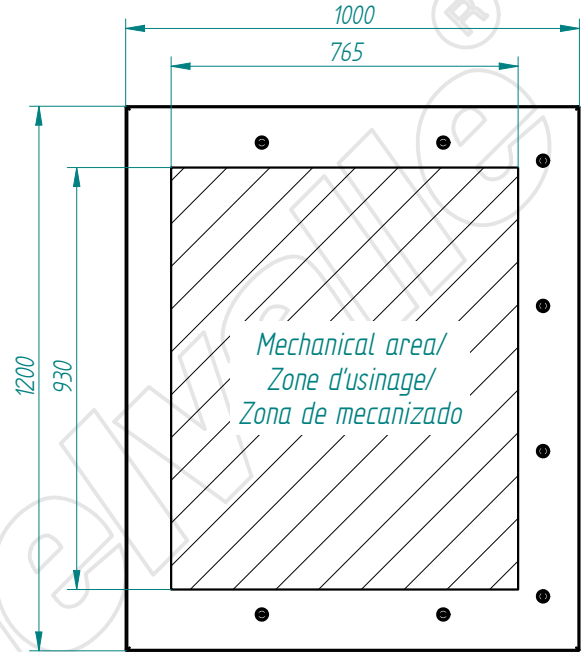
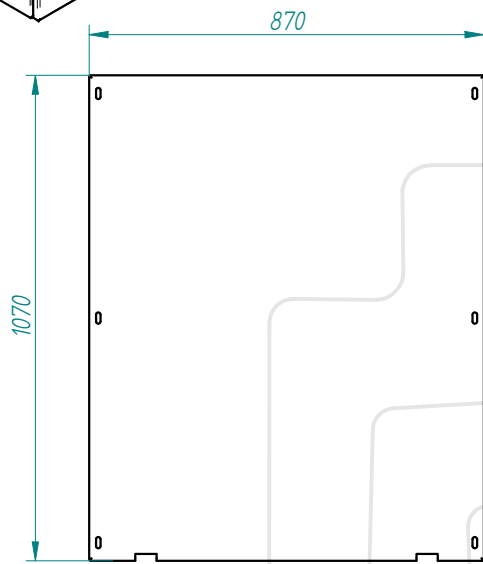
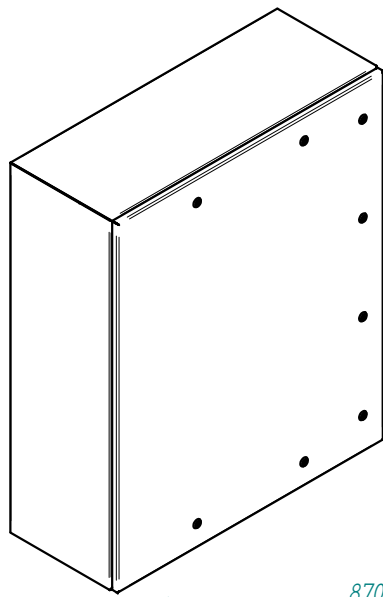

TOLERANCIA GENERAL DE MECANIZACION segun DIN 7168					Referencia:		FECHA:	FIRMA:	
						DIBUJADO:	27/04/2015	D.Martinez	
						APROBADO:	27/04/2015	D.Martinez	
	Creación del documento	27/04/2015	D.MTNEZ	A	-	DESIGNACIÓN:			Nº PLANO:
	MODIFICACIONES	FECHA:	FIRMA:	REVISIÓN:	plegado: acabado:	tribex -1200x1000x400-estandar			



This present document and its contents are confidential, and are the exclusive intellectual and / or industrial property of DEVALLE... in addition to any technology, design, invention, work, process, know-how, calculation, manual, method, solution, idea, improvement, drawing, diagram, modification, contribution and, in short, any associated information or documentation involving industrial or intellectual property developed or supplied by DEVALLE on the occasion of the quote, order execution or incorporated into the design or operation of the supply. The recipient may not use such property in his favour or in that of a third party for purposes other than the fulfilment of the order and the operation and maintenance of the supply, without the prior written consent of DEVALLE. It is strictly forbidden to totally or partially reproduce this document and to misuse it and / or to show it to third parties. The infringing parties shall be required to pay the corresponding compensation for damages, and any other legal or criminal responsibility if the infringement may give rise to.

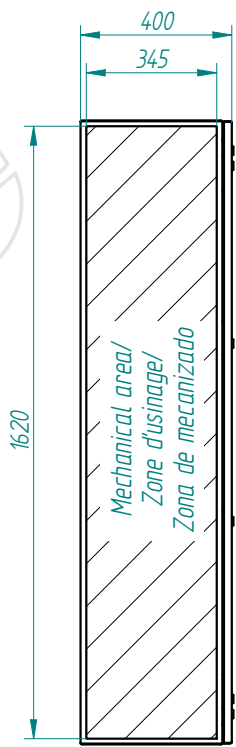
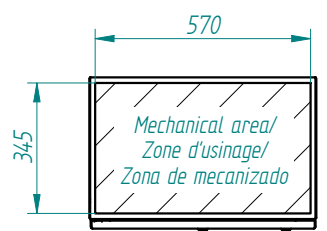
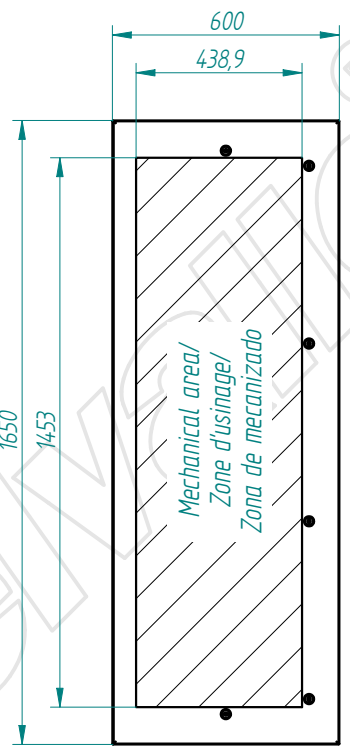
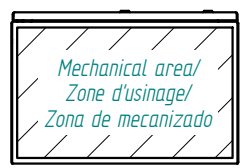
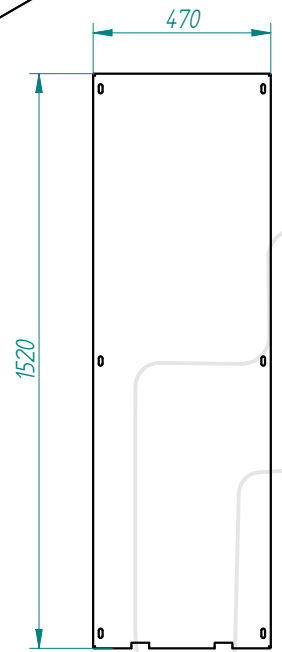
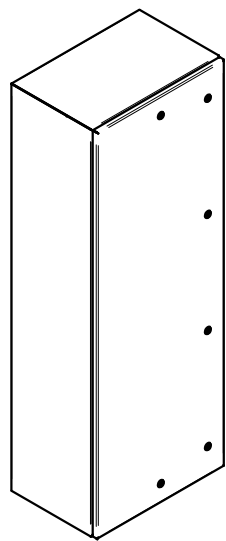

TOLERANCIA GENERAL DE MECANIZACION segun DIN 7168	Creación del documento	27/04/2015	D.MTNEZ	A	Referencia: - plegado: acabado:
	MODIFICACIONES	FECHA:	FIRMA:	REVISIÓN:	

DIBUJADO:	FECHA:	FIRMA:
APROBADO:	27/04/2015	D.Martinez
DESIGNACIÓN:		
tribex -1650x600x400-estandar		

	Nº PLANO:



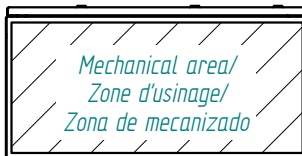
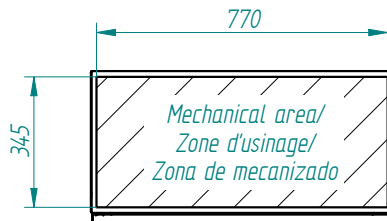
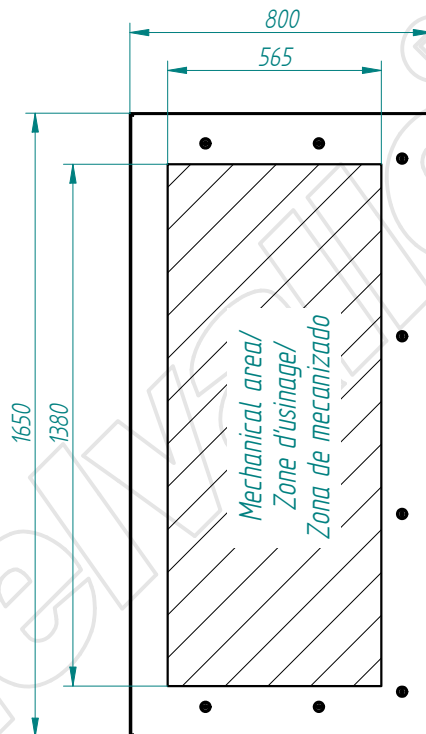
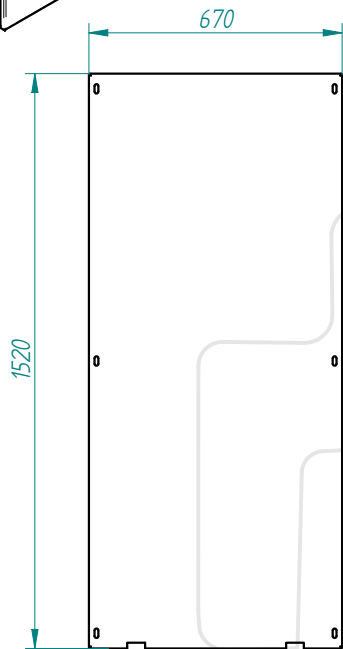
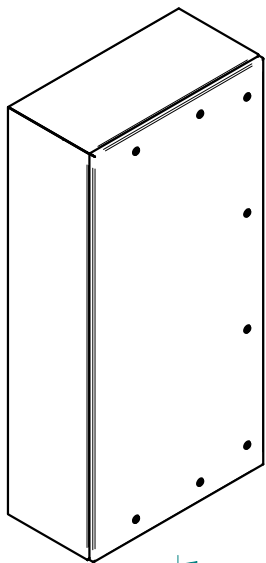

This present document and its contents are confidential, and are the exclusive intellectual and / or industrial property of DELVALLE. In addition to any technology, design, invention, work, process, know-how, calculation, manual, method, solution, idea, improvement, drawing, diagram, modification, contribution and, in short, any associated information or documentation involving industrial or intellectual property developed or supplied by DELVALLE on the occasion of the quote, order execution or incorporated into the design or operation of the supply. The recipient may not use such property in his favour or in that of a third party for purposes other than the fulfilment of the order and the operation and maintenance of the supply, without the prior written consent of DELVALLE. It is strictly forbidden to totally or partially reproduce this document and to misuse it and / or to show it to third parties. The infringing parties shall be required to pay the corresponding compensation for damages, and any other legal or criminal responsibilities. The infringement may give rise to.

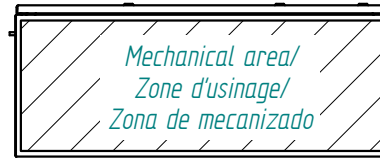
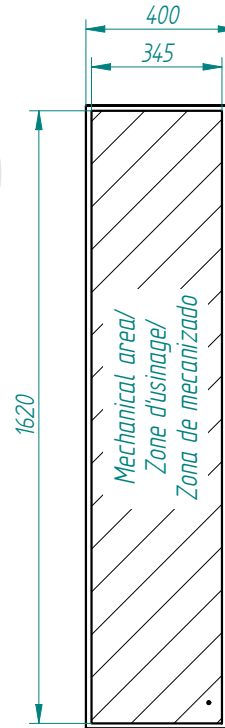
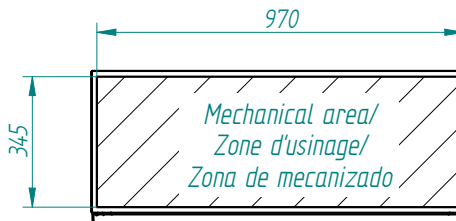
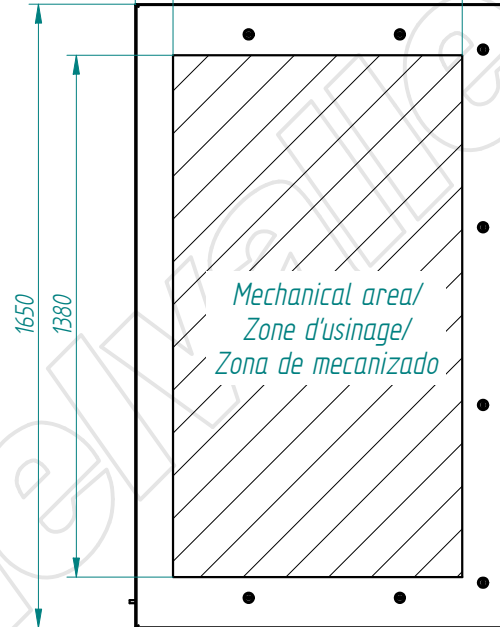
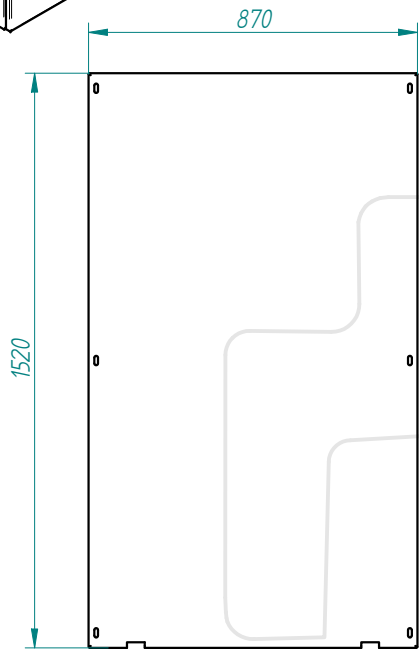
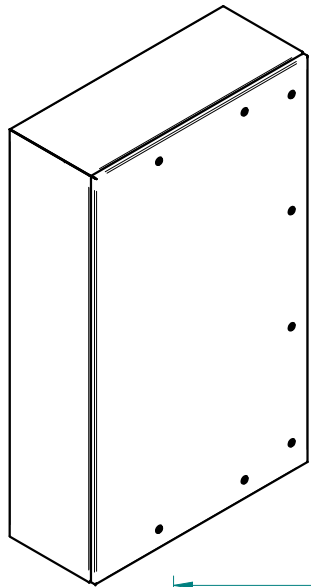

TOLERANCIA GENERAL DE MECANIZACION segun DIN 7168					Referencia: - plegado: acabado:	DIBUJADO:	FECHA:	FIRMA:	 Nº PLANO:
						APROBADO:	27/04/2015	D.Martinez	
	Creación del documento	27/04/2015	D.MTNEZ	A		DESIGNACIÓN:	27/04/2015	D.Martinez	
	MODIFICACIONES	FECHA:	FIRMA:	REVISIÓN:		tribex -1650x800x400-estandar			

This present document and its contents are confidential, and are the exclusive intellectual and / or industrial property of DELVALLE. In addition to any technology, design, invention, work, process, know-how, calculation, manual, method, solution, idea, improvement, drawing, diagram, modification, contribution and, in short, any associated information or documentation involving industrial or intellectual property developed or supplied by DELVALLE on the occasion of the quote, order execution or incorporated into the design or operation of the supply. The recipient may not use such property in his favour or in that of a third party for purposes other than the fulfilment of the order and the operation and maintenance of the supply, without the prior written consent of DELVALLE. It is strictly forbidden to totally or partially reproduce this document and to misuse it and / or to show it to third parties. The infringing parties shall be required to pay the corresponding compensation for damages, and any other legal or criminal responsibility. The infringement may give rise to.



TOLERANCIA GENERAL DE MECANIZACION segun DIN 7168					Referencia: - plegado: acabado:	DIBUJADO:	FECHA:	FIRMA:	 Nº PLANO:
						APROBADO:	27/04/2015	D.Martinez	
	Creación del documento	27/04/2015	D.MTNEZ	A		DESIGNACIÓN:	27/04/2015	D.Martinez	
	MODIFICACIONES	FECHA:	FIRMA:	REVISIÓN:		tribex -1650x1000x400-estandar			

This present document and its contents are confidential, and are the exclusive intellectual and / or industrial property of DEVALLE. In addition to any technology, design, invention, work, process, know-how, calculation, manual, method, solution, idea, improvement, drawing, diagram, modification, contribution and, in short, any associated information or documentation involving industrial or intellectual property developed or supplied by DEVALLE on the occasion of the quote, order execution or incorporated into the design or operation of the supply. The recipient may not use such property in his favour or in that of a third party for purposes other than the fulfilment of the order and the operation and maintenance of the supply, without the prior written consent of DEVALLE. It is strictly forbidden to totally or partially reproduce this document and to misuse it and / or to show it to third parties. The infringing parties shall be required to pay the corresponding compensation for damages and any other legal or criminal responsibilities. The infringement may give rise to.

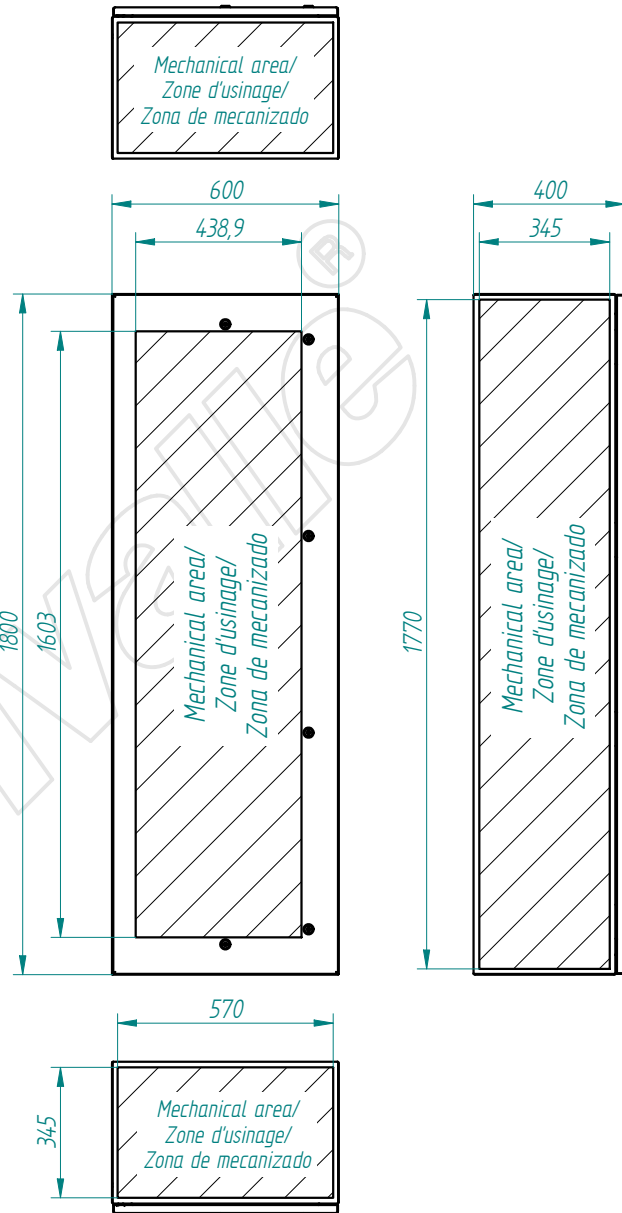
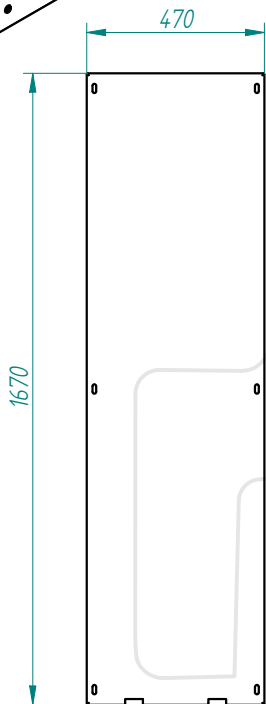
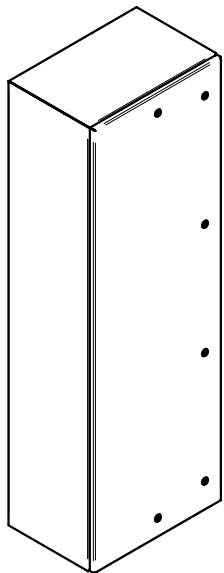

TOLERANCIA GENERAL DE MECANIZACION segun DIN 7168					Referencia:		FECHA:	FIRMA:	
						DIBUJADO:	27/04/2015	D.Martinez	
						APROBADO:	27/04/2015	D.Martinez	
	Creación del documento	27/04/2015	D.MTNEZ	A	-	DESIGNACIÓN:			Nº PLANO:
	MODIFICACIONES	FECHA:	FIRMA:	REVISIÓN:	plegado: acabado:	tribex -1800x600x400-estandar			



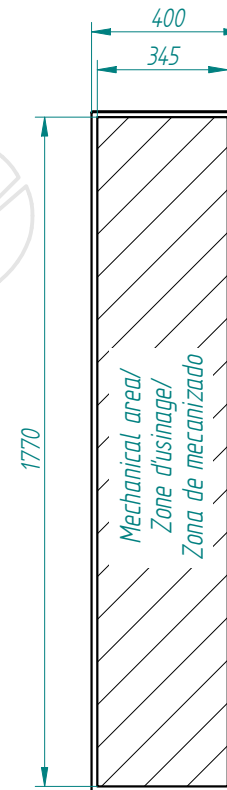
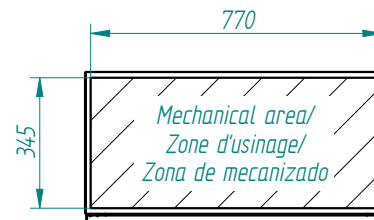
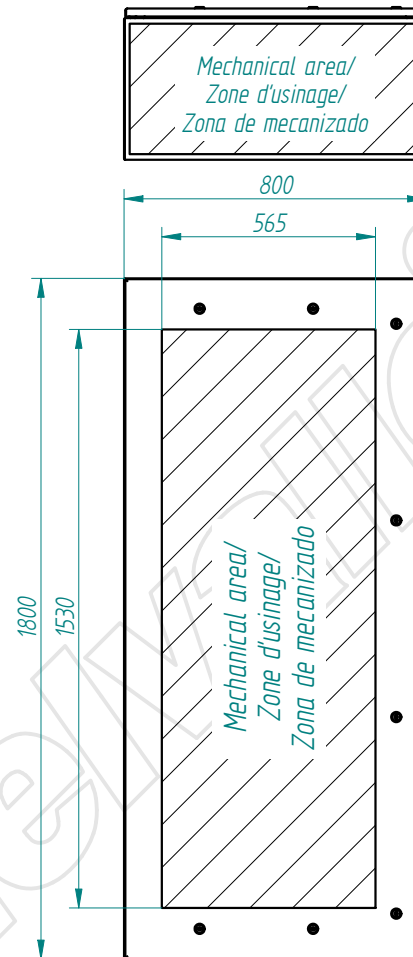
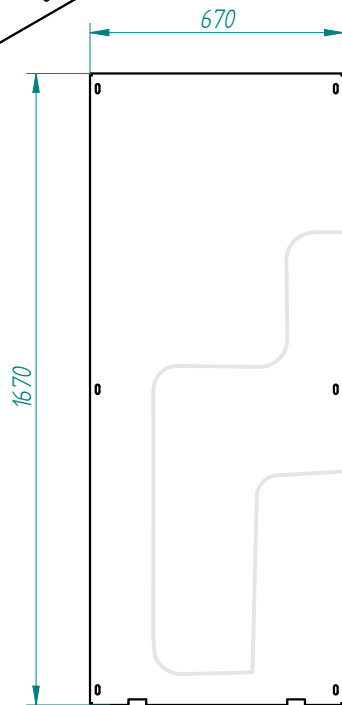
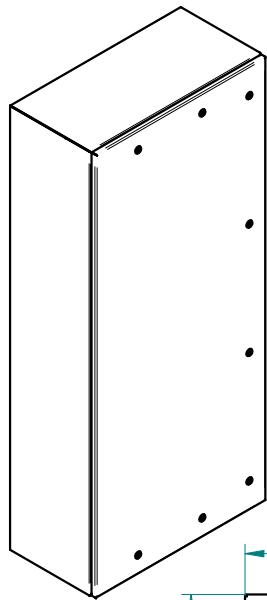

This present document and its contents are confidential, and are the exclusive intellectual and / or industrial property of DELVALLE. In addition to any technology, design, invention, work, process, know-how, calculation, manual, method, solution, idea, improvement, drawing, diagram, modification, contribution and, in short, any associated information or documentation involving industrial or intellectual property developed or supplied by DELVALLE on the occasion of the quote, order execution or incorporated into the design or operation of the supply. The recipient may not use such property in his favour or in that of a third party for purposes other than the fulfilment of the order and the operation and maintenance of the supply, without the prior written consent of DELVALLE. It is strictly forbidden to totally or partially reproduce this document and to misuse it and / or to show it to third parties. The infringing parties shall be required to pay the corresponding compensation for damages, and any other legal or criminal responsibilities. The infringement may give rise to.

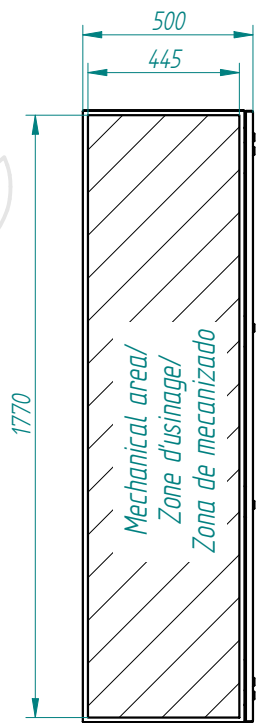
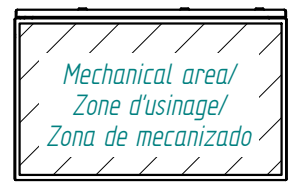
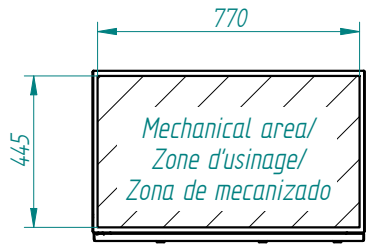
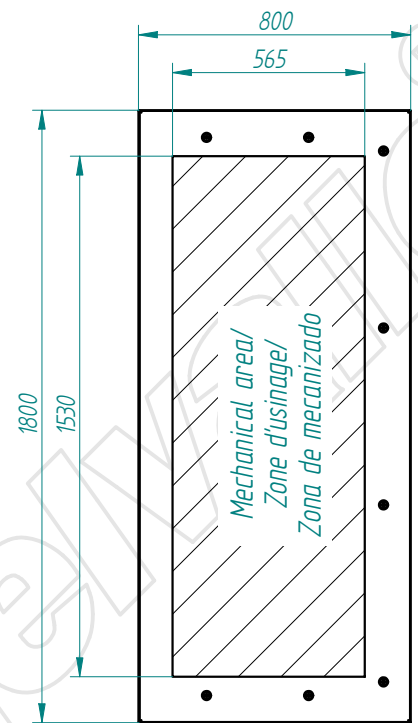
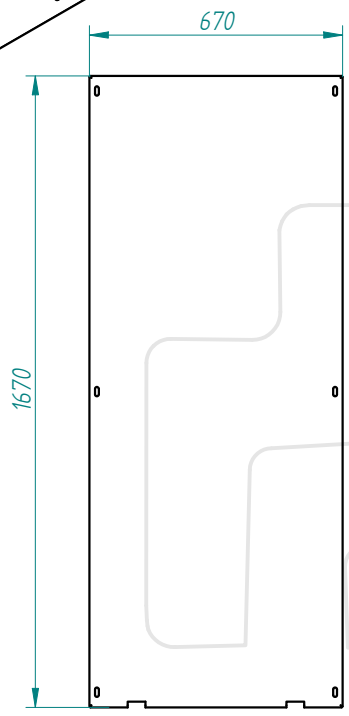
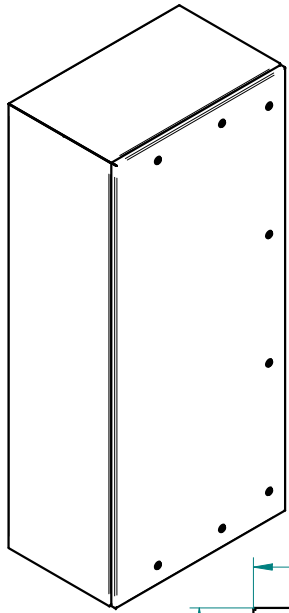

TOLERANCIA GENERAL DE MECANIZACION segun DIN 7168					Referencia: - plegado: acabado:	DIBUJADO:	FECHA:	FIRMA:	 Nº PLANO:
						APROBADO:	27/04/2015	D.Martínez	
	Creación del documento	27/04/2015	D.MTNEZ	A		DESIGNACIÓN:	27/04/2015	D.Martínez	
	MODIFICACIONES	FECHA:	FIRMA:	REVISIÓN:		tribex -1800x800x400-estandar			

This present document and its contents are confidential, and are the exclusive intellectual and / or industrial property of DELVALLE. In addition to any technology, design, invention, work, process, know-how, calculation, manual, method, solution, idea, improvement, drawing, diagram, modification, contribution and, in short, any associated information involving industrial or intellectual property developed or supplied by DELVALLE on the occasion of the quote, order execution or incorporated into the design or operation of the supply. The recipient may not use such property in his favour or in that of a third party for purposes other than the fulfilment of the order and the operation and maintenance of the supply, without the prior written consent of DELVALLE. It is strictly forbidden to totally or partially reproduce this document and to misuse it and / or to show it to third parties. The infringing parties shall be required to pay the corresponding compensation for damages, and any other legal or criminal responsibility is the infringement may give rise to.



TOLERANCIA GENERAL DE MECANIZACION segun DIN 7168	Creación del documento	27/04/2015	D.MTNEZ	A	Referencia: - plegado: acabado:	DIBUJADO:	FECHA:	FIRMA:	 Nº PLANO:
	MODIFICACIONES	FECHA:	FIRMA:	REVISIÓN:		APROBADO:	27/04/2015	D.Martínez	
						DESIGNACIÓN:	tribex -1800x800x500-estandar		

This present document and its contents are confidential, and are the exclusive intellectual and / or industrial property of DELVALLE ., in addition to any technology, design, invention, work, process, know-how, calculation, manual, method, solution, idea, improvement, drawing, diagram, modification, contribution and, in short, any associated information involving industrial or intellectual property developed or supplied by DELVALLE on the occasion of the quote, order execution or incorporated into the design or operation of the supply. The recipient may not use such property in his favour or in that of a third party for purposes other than the fulfilment of the order and the operation and maintenance of the supply, without the prior written consent of DELVALLE. It is strictly forbidden to totally or partially reproduce this document and to misuse it and / or to show it to third parties. The infringing parties shall be required to pay the corresponding compensation for damages, and any other legal or criminal responsibility is the infringement may give rise to.

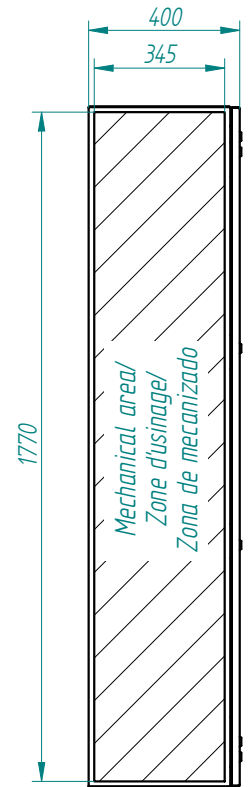
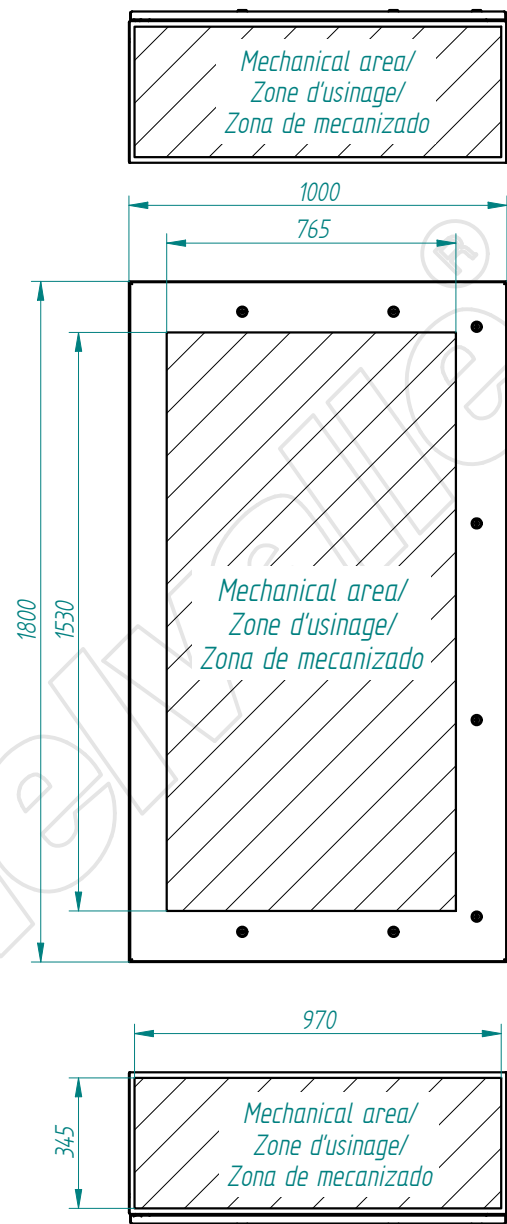
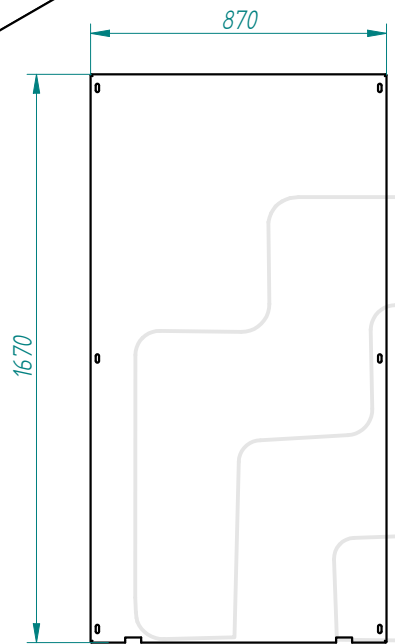
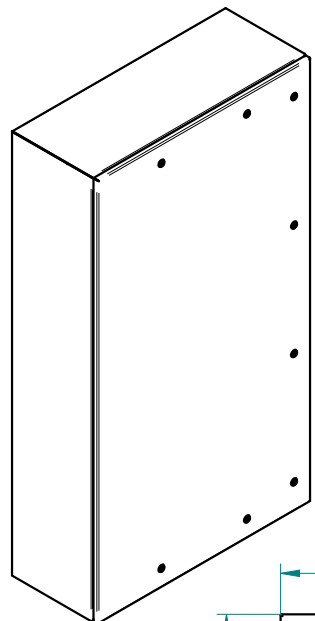

TOLERANCIA GENERAL DE MECANIZACION segun DIN 7168

Creación del documento	27/04/2015	D.MTNEZ	A
MODIFICACIONES	FECHA:	FIRMA:	REVISIÓN:

Referencia: -
plegado:
acabado:

DIBUJADO:	FECHA:	FIRMA:
APROBADO:	27/04/2015	D.Martinez
DESIGNACIÓN:		
tribex -1800x1000x400-estandar		

Nº PLANO:



This present document and its contents are confidential, and are the exclusive intellectual and / or industrial property of DELVALLE. In addition to any technology, design, invention, work, process, know-how, calculation, manual, method, solution, idea, improvement, drawing, diagram, modification, contribution and, in short, any associated information or documentation involving industrial or intellectual property developed or supplied by DELVALLE on the occasion of the quote, order execution or incorporated into the design or operation of the supply. The recipient may not use such property in his favour or in that of a third party for purposes other than the fulfilment of the order and the operation and maintenance of the supply, without the prior written consent of DELVALLE. It is strictly forbidden to totally or partially reproduce this document and to misuse it and / or to show it to third parties. The infringing parties shall be required to pay the corresponding compensation for damages and any other legal or criminal responsibility. The infringement may give rise to.

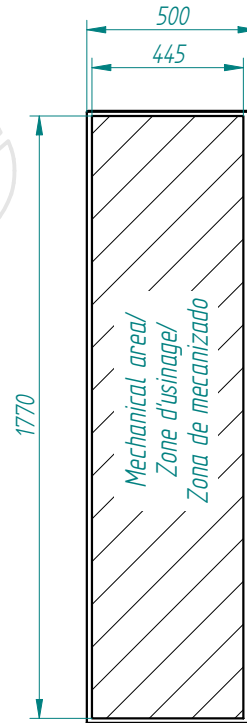
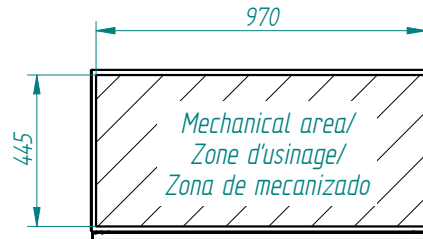
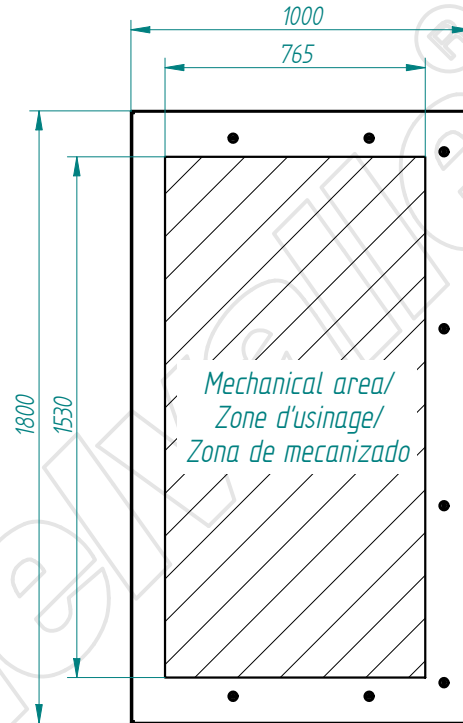
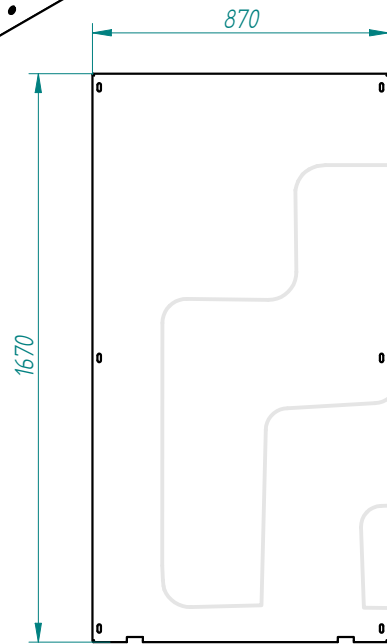
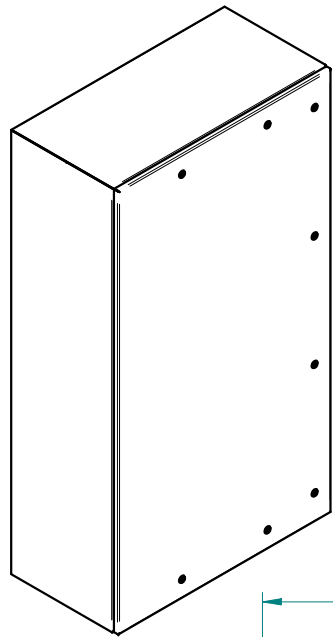

TOLERANCIA GENERAL DE MECANIZACION segun DIN 7168					Referencia:		FECHA:	FIRMA:	
						DIBUJADO:	27/04/2015	D.Martinez	
						APROBADO:	27/04/2015	D.Martinez	
	Creación del documento	27/04/2015	D.MTNEZ	A	-	DESIGNACIÓN:			Nº PLANO:
	MODIFICACIONES	FECHA:	FIRMA:	REVISIÓN:	plegado: acabado:	tribex -1800x1000x500-estandar			

This present document and its contents are confidential, and are the exclusive intellectual and / or industrial property of DELVALLE. In addition to any technology, design, invention, work, process, know-how, calculation, manual, method, solution, idea, improvement, drawing, diagram, modification, contribution and, in short, any associated information involving industrial or intellectual property developed or supplied by DELVALLE on the occasion of the quote, order execution or incorporated into the design or operation of the supply. The recipient may not use such property in his favour or in that of a third party for purposes other than the fulfilment of the order and the operation and maintenance of the supply, without the prior written consent of DELVALLE. It is strictly forbidden to totally or partially reproduce this document and to misuse it and / or to show it to third parties. The infringing parties shall be required to pay the corresponding compensation for damages, and any other legal or criminal responsibility if the infringement may give rise to.

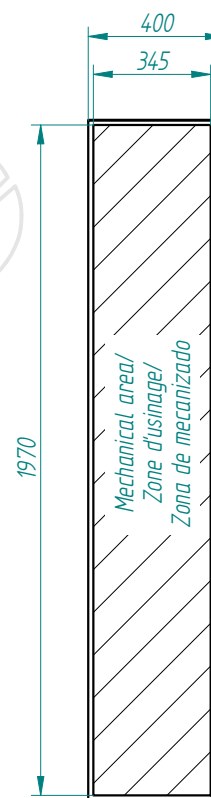
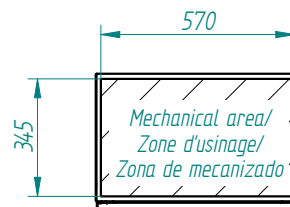
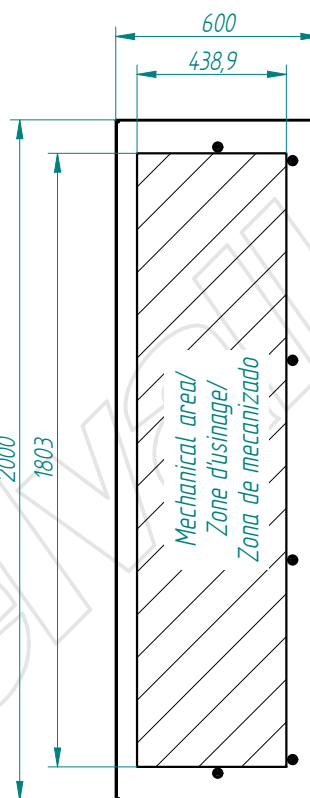
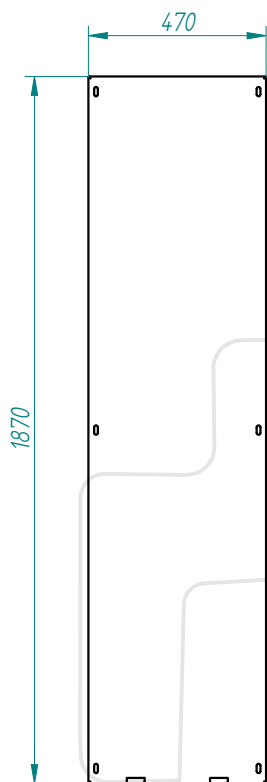
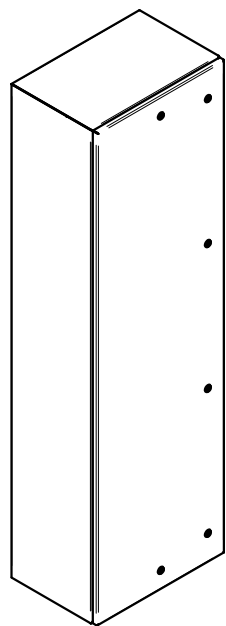

Mechanical area/
Zone d'usinage/
Zona de mecanizado

Mechanical area/
Zone d'usinage/
Zona de mecanizado

TOLERANCIA GENERAL
DE MECANIZACION
segun DIN 7168

Creación del documento	27/04/2015	D.MTNEZ	A
MODIFICACIONES	FECHA:	FIRMA:	REVISIÓN:

Referencia:

DIBUJADO:	FECHA:	FIRMA:
APROBADO:	27/04/2015	D.Martinez
DESIGNACIÓN:		
tribex -2000x600x400-estandar		

Nº PLANO:



This present document and its contents are confidential, and are the exclusive intellectual and / or industrial property of DELVALLE. In addition to any technology, design, invention, work, process, know-how, calculation, manual, method, solution, idea, improvement, drawing, diagram, modification, contribution and, in short, any associated information or documentation involving industrial or intellectual property developed or supplied by DELVALLE on the occasion of the quote, order execution or incorporated into the design or operation of the supply. The recipient may not use such property in his favour or in that of a third party for purposes other than the fulfilment of the order and the operation and maintenance of the supply, without the prior written consent of DELVALLE. It is strictly forbidden to totally or partially reproduce this document and to misuse it and / or to show it to third parties. The infringing parties shall be required to pay the corresponding compensation for damages and any other legal or criminal responsibility & the infringement may give rise to.

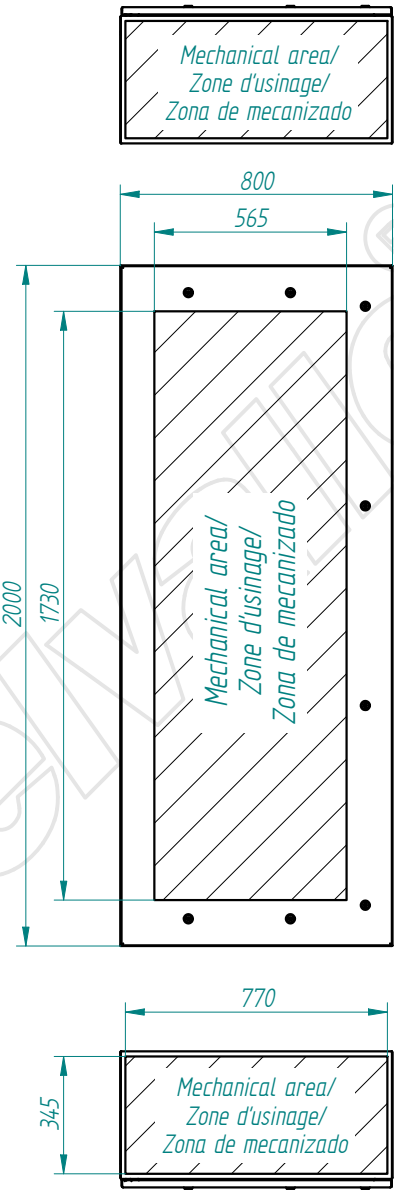
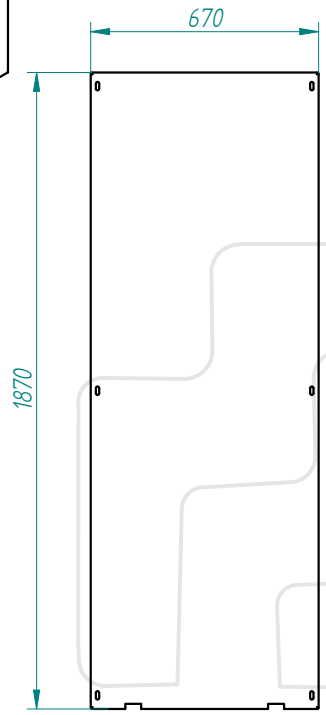
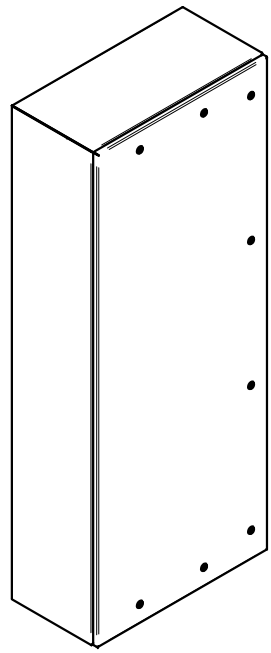

TOLERANCIA GENERAL DE MECANIZACION segun DIN 7168	Creación del documento	27/04/2015	D.MTNEZ	A	Referencia: - plegado: acabado:	DIBUJADO:	FECHA:	FIRMA:	 Nº PLANO:
	MODIFICACIONES	FECHA:	FIRMA:	REVISIÓN:		APROBADO:	27/04/2015	D.Martínez	
						DESIGNACIÓN:	tribex -2000x800x400-estandar		



This present document and its contents are confidential, and are the exclusive intellectual and / or industrial property of DELVALLE. In addition to any technology, design, invention, work, process, know-how, calculation, manual, method, solution, idea, improvement, drawing, diagram, modification, contribution and, in short, any associated information or documentation involving industrial or intellectual property developed or supplied by DELVALLE on the occasion of the quote, order execution or incorporated into the design or operation of the supply. The recipient may not use such property in his favour or in that of a third party for purposes other than the fulfilment of the order and the operation and maintenance of the supply, without the prior written consent of DELVALLE. It is strictly forbidden to totally or partially reproduce this document and to misuse it and / or to show it to third parties. The infringing parties shall be required to pay the corresponding compensation for damages, and any other legal or criminal responsibility if the infringement may give rise to.

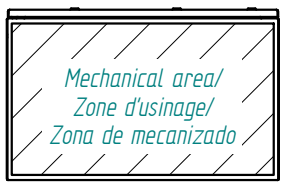
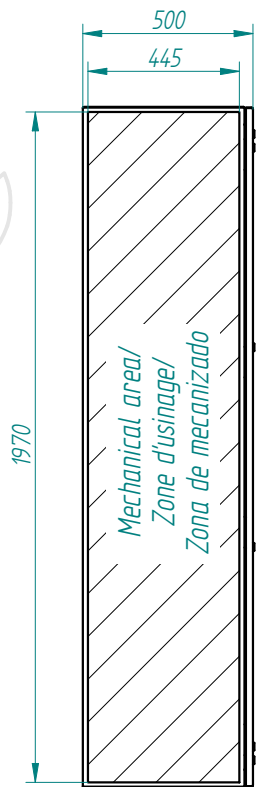
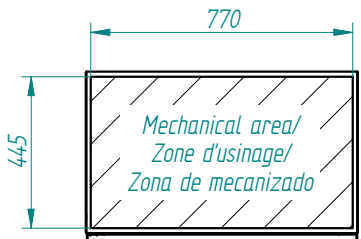
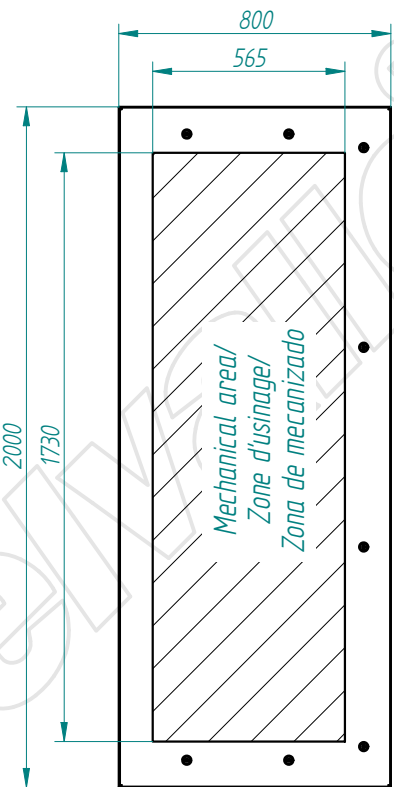
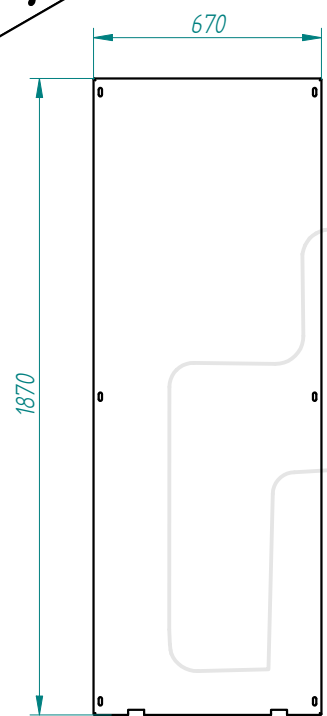
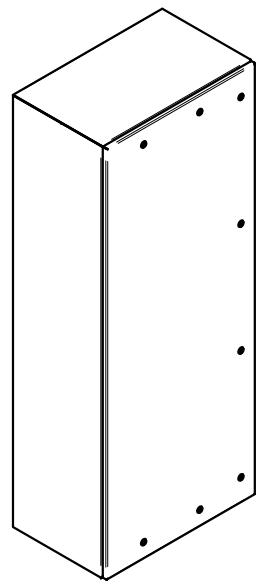

TOLERANCIA GENERAL DE MECANIZACION segun DIN 7168	Creación del documento	27/04/2015	D.MTNEZ	A	Referencia: - plegado: - acabado:	DIBUJADO:	FECHA:	FIRMA:	 Nº PLANO:
	MODIFICACIONES	FECHA:	FIRMA:	REVISIÓN:		APROBADO:	27/04/2015	D.Martínez	
						DESIGNACIÓN:	tribex -2000x800x500-estandar		



This present document and its contents are confidential, and are the exclusive intellectual and / or industrial property of DELVALLE. In addition to any technology, design, invention, work, process, know-how, calculation, manual, method, solution, idea, improvement, drawing, diagram, modification, contribution and, in short, any associated information involving industrial or intellectual property developed or supplied by DELVALLE on the occasion of the quote, order execution or incorporated into the design or operation of the supply, the recipient may not use such property in his favour or in that of a third party for purposes other than the fulfilment of the order and the operation and maintenance of the supply, without the prior written consent of DELVALLE. It is strictly forbidden to totally or partially reproduce this document and to misuse it and / or to show it to third parties. The infringing parties shall be required to pay the corresponding compensation for damages, and any other legal or criminal, responsible & the infringement may give rise to.

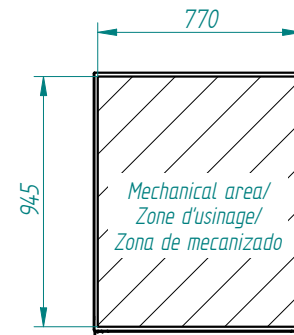
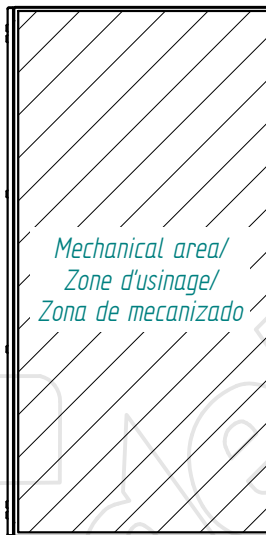
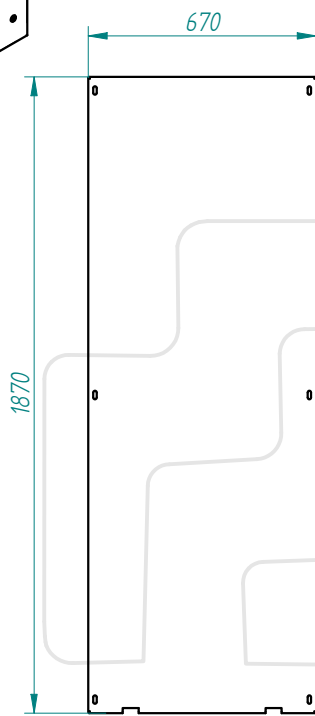
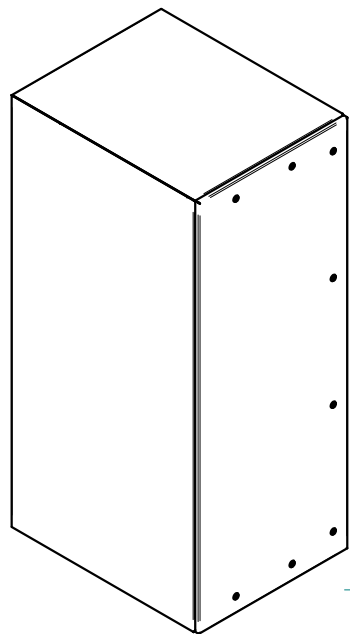

TOLERANCIA GENERAL DE MECANIZACION segun DIN 7168	Creación del documento	27/04/2015	D.MTNEZ	A	Referencia: - plegado: - acabado:	DIBUJADO:	FECHA:	FIRMA:	
	MODIFICACIONES	FECHA:	FIRMA:	REVISIÓN:		APROBADO:	27/04/2015	D.Martínez	
DESIGNACIÓN:						tribex -2000x800x1000-estandar			Nº PLANO:



This present document and its contents are confidential, and are the exclusive intellectual and / or industrial property of DELVALLE. In addition to any technology, design, invention, work, process, know-how, calculation, manual, method, solution, idea, improvement, drawing, diagram, modification, contribution and, in short, any associated information or documentation involving industrial or intellectual property developed or supplied by DELVALLE on the occasion of the quote, order execution or incorporated into the design or operation of the supply. The recipient may not use such property in his favour or in that of a third party for purposes other than the fulfilment of the order and the operation and maintenance of the supply, without the prior written consent of DELVALLE. It is strictly forbidden to totally or partially reproduce this document and to misuse it and / or to show it to third parties. The infringing parties shall be required to pay the corresponding compensation for damages and any other legal or criminal responsibility. The infringement may give rise to.

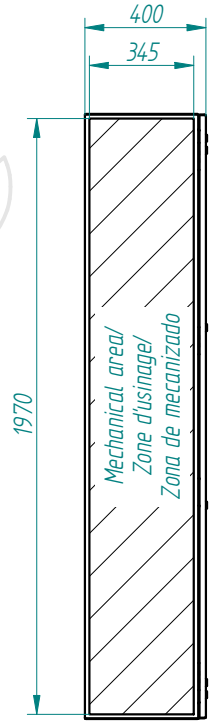
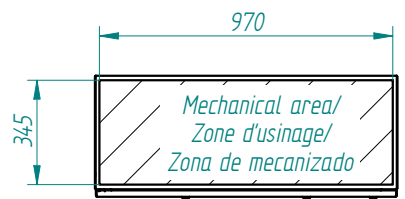
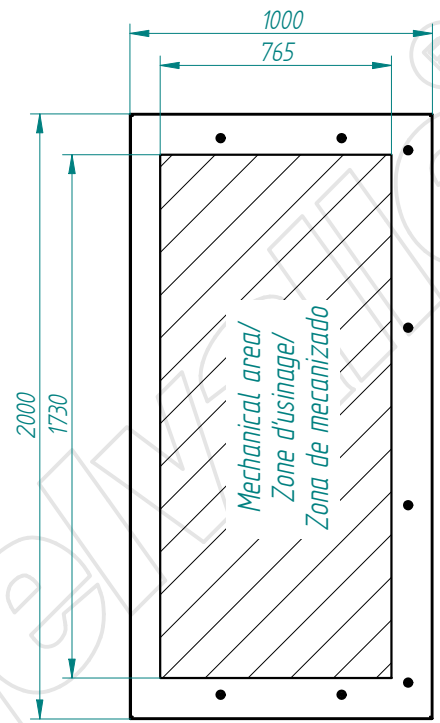
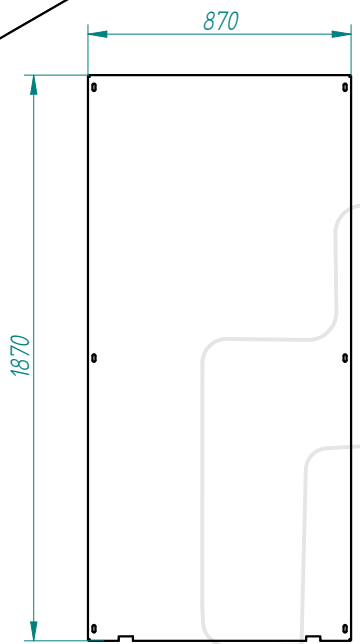
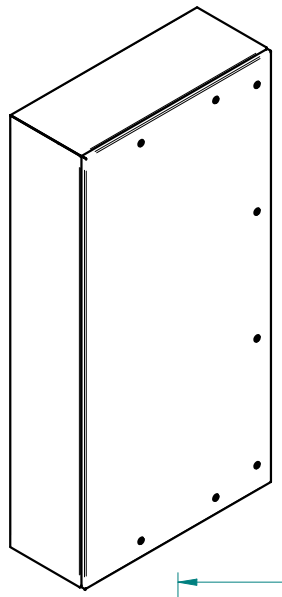

Mechanical area/
Zone d'usinage/
Zona de mecanizado

Mechanical area/
Zone d'usinage/
Zona de mecanizado

TOLERANCIA GENERAL DE MECANIZACION segun DIN 7168	Creación del documento	27/04/2015	D.MTNEZ	A
	MODIFICACIONES	FECHA:	FIRMA:	REVISIÓN:

Referencia:	DIBUJADO:	FECHA:	FIRMA:
	APROBADO:	27/04/2015	D.Martinez
DESIGNACIÓN:			Nº PLANO:
tribex -2000x1000x400-estandar			



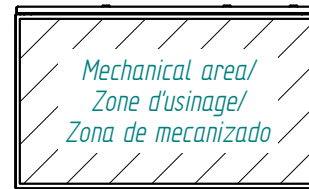
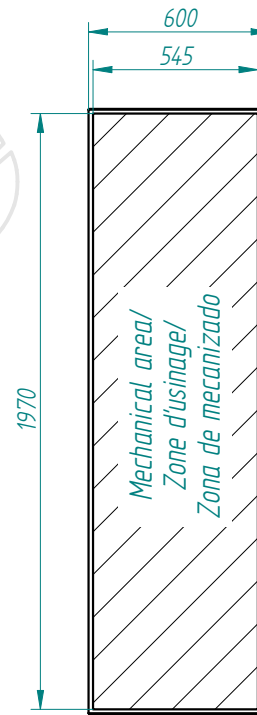
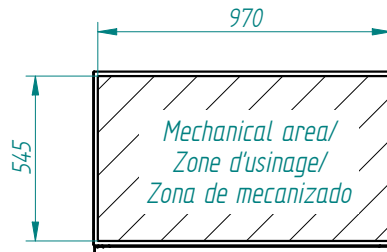
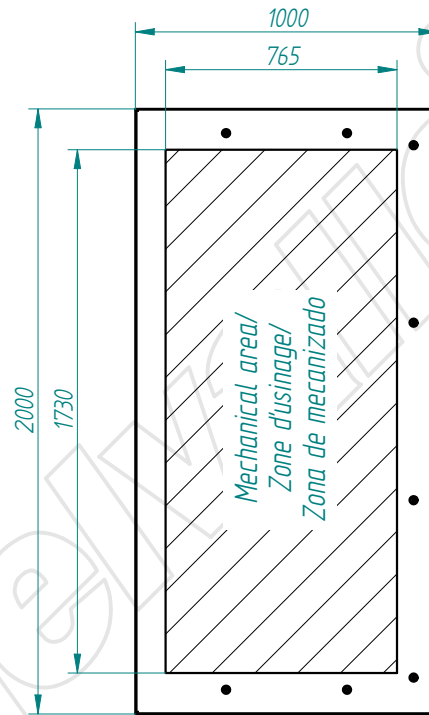
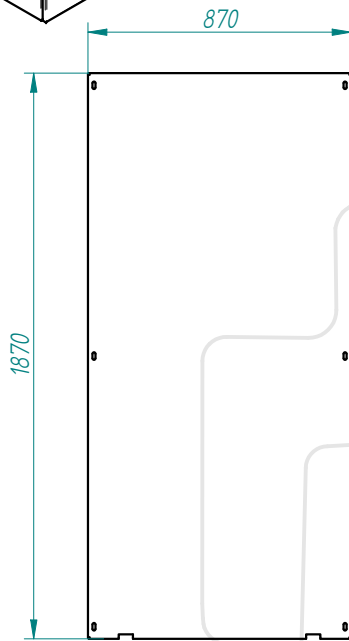
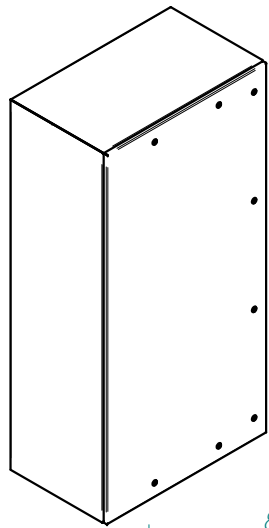

This present document and its contents are confidential, and are the exclusive intellectual and / or industrial property of DELVALLE. In addition to any technology, design, invention, work, process, know-how, calculation, manual, method, solution, idea, improvement, drawing, diagram, modification, contribution and, in short, any associated information or documentation involving industrial or intellectual property developed or supplied by DELVALLE on the occasion of the quote, order execution or incorporated into the design or operation of the supply. The recipient may not use such property in his favour or in that of a third party for purposes other than the fulfilment of the order and the operation and maintenance of the supply, without the prior written consent of DELVALLE. It is strictly forbidden to totally or partially reproduce this document and to misuse it and / or to show it to third parties. The infringing parties shall be required to pay the corresponding compensation for damages, and any other legal or criminal responsibility is the infringement may give rise to.

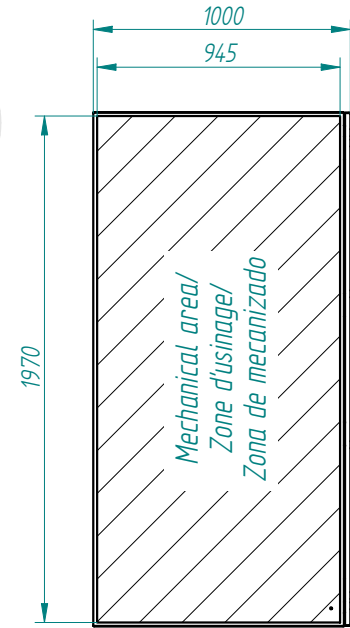
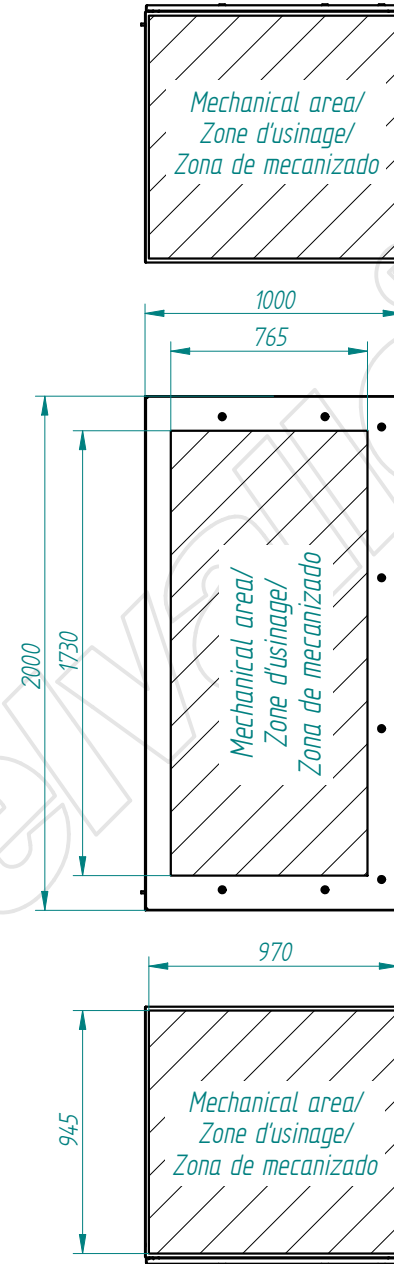
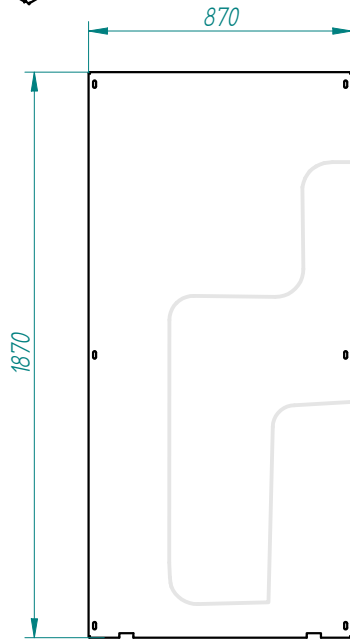
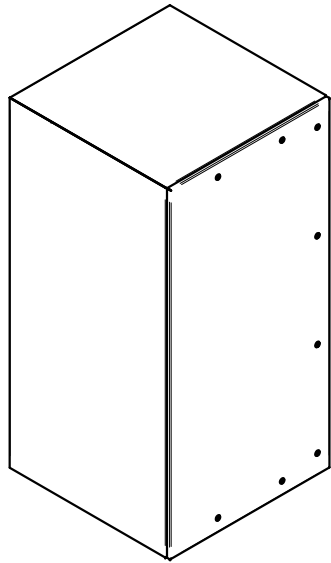

TOLERANCIA GENERAL DE MECANIZACION segun DIN 7168					Referencia:	DIBUJADO:	FECHA:	FIRMA:	
						APROBADO:	27/04/2015	D.Martinez	
	Creación del documento	27/04/2015	D.MTNEZ	A	-	DESIGNACIÓN:			Nº PLANO:
	MODIFICACIONES	FECHA:	FIRMA:	REVISIÓN:	plegado: acabado:	tribex -2000x1000x600-estandar			

This present document and its contents are confidential, and are the exclusive intellectual and / or industrial property of DELVALLE. In addition to any technology, design, invention, work, process, know-how, calculation, manual, method, solution, idea, improvement, drawing, diagram, modification, contribution and, in short, any associated information or documentation involving industrial or intellectual property developed or supplied by DELVALLE on the occasion of the quote, order execution or incorporated into the design or operation of the supply. The recipient may not use such property in his favour or in that of a third party for purposes other than the fulfilment of the order and the operation and maintenance of the supply, without the prior written consent of DELVALLE. It is strictly forbidden to totally or partially reproduce this document and to misuse it or to show it to third parties. The infringing parties shall be required to pay the corresponding compensation for damages, and any other legal or criminal responsibility if the infringement may give rise to.



TOLERANCIA GENERAL DE MECANIZACION segun DIN 7168

Creación del documento	27/04/2015	D.MTNEZ	A
MODIFICACIONES	FECHA:	FIRMA:	REVISIÓN:

Referencia:

DIBUJADO:	FECHA:	FIRMA:
APROBADO:	27/04/2015	D.Martínez
DESIGNACIÓN:	tribex -2000x1000x1000-estandar	

Nº PLANO:



This present document and its contents are confidential, and are the exclusive intellectual and / or industrial property of DELVALLE. In addition to any technology, design, invention, work, process, know-how, calculation, manual, method, solution, idea, improvement, drawing, diagram, modification, contribution and, in short, any associated information involving industrial or intellectual property developed or supplied by DELVALLE on the occasion of the quote, order execution or incorporated into the design or operation of the supply. The recipient may not use such property in his favour or in that of a third party for purposes other than the fulfilment of the order and the operation and maintenance of the supply, without the prior written consent of DELVALLE. It is strictly forbidden to totally or partially reproduce this document and to misuse it and / or to show it to third parties. The infringing parties shall be required to pay the corresponding compensation for damages, and any other legal or criminal responsibility is the infringement may give rise to.

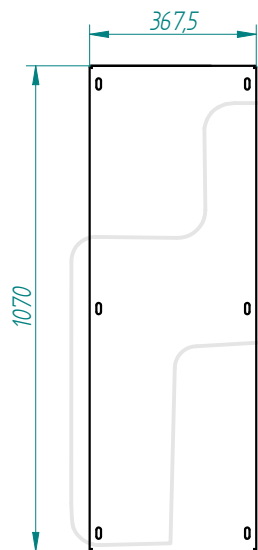
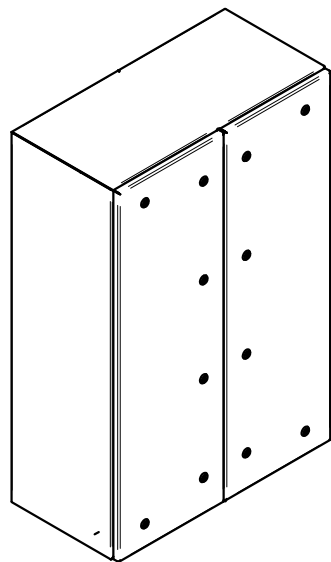

2 PLACAS

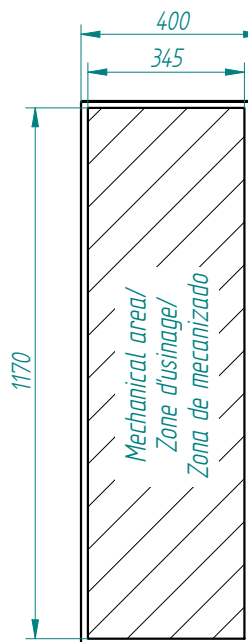
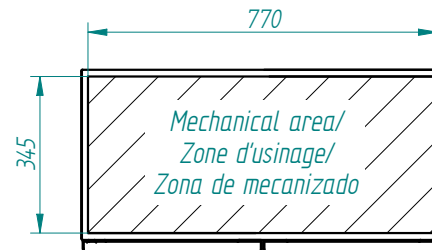
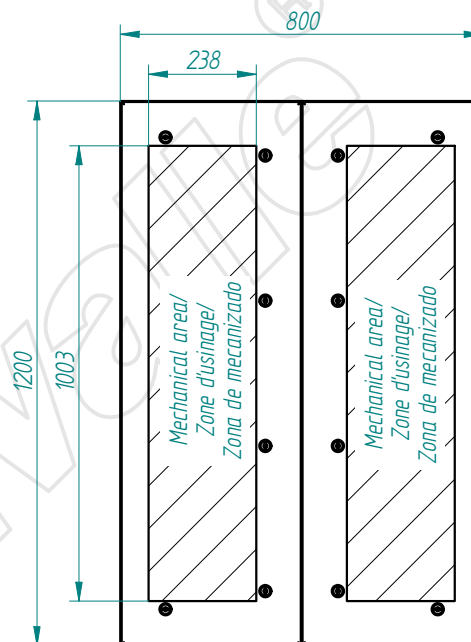

TOLERANCIA GENERAL DE MECANIZACION según DIN 7168					Referencia:		FECHA:	FIRMA:	
							28/04/2015	D.Martínez	
	Creación del documento	28/04/2015	D.MTNEZ	A	-	DESIGNACIÓN:			Nº PLANO:
	MODIFICACIONES	FECHA:	FIRMA:	REVISIÓN:	plegado: acabado:	tribex 2p-1200x800x400-estandar.			



This present document and its contents are confidential, and are the exclusive intellectual and / or industrial property of DEVALLE. In addition to any technology, design, invention, work, process, know-how, calculation, manual, method, solution, idea, improvement, drawing, diagram, modification, contribution and, in short, any associated information or documentation involving industrial or intellectual property developed or supplied by DEVALLE on the occasion of the quote, order execution or incorporated into the design or operation of the supply. The recipient may not use such property in his favour or in that of a third party for purposes other than the fulfilment of the order and the operation and maintenance of the supply, without the prior written consent of DEVALLE. It is strictly forbidden to totally or partially reproduce this document and to misuse it or to show it to third parties. The infringing parties shall be required to pay the corresponding compensation for damages, and any other legal or criminal responsibility if the infringement may give rise to.

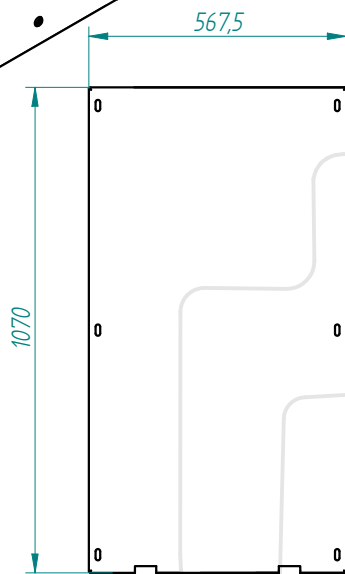
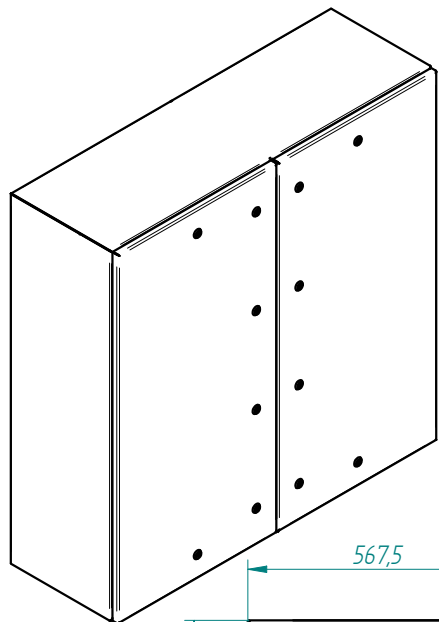

2 PLACAS

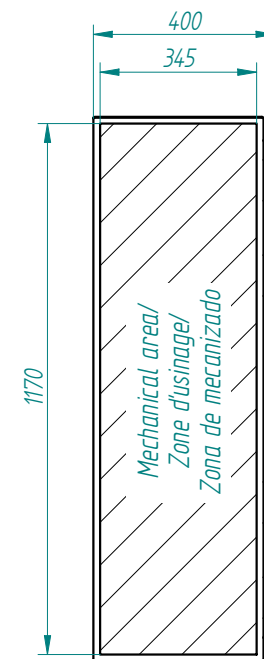
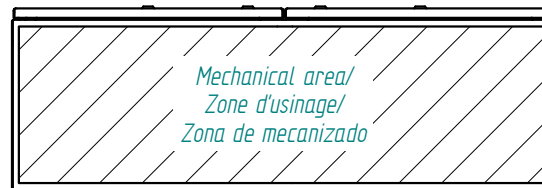
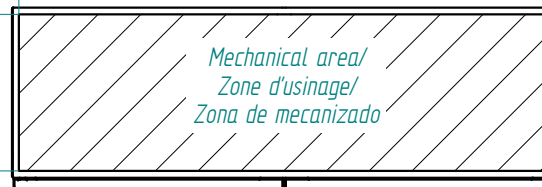
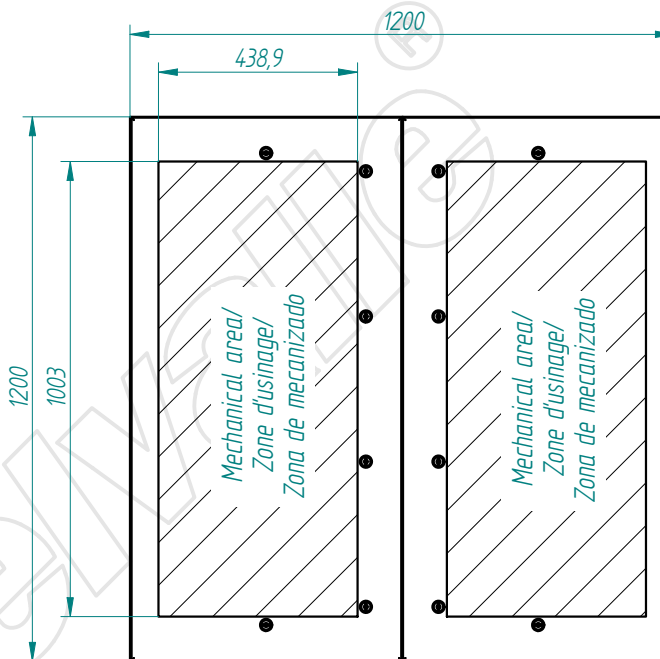

TOLERANCIA GENERAL
DE MECANIZACION
segun DIN 7168

Creación del documento	27/04/2015	D.MTNEZ	A
MODIFICACIONES	FECHA:	FIRMA:	REVISIÓN:

Referencia:

DIBUJADO:	FECHA:	FIRMA:
APROBADO:	27/04/2015	D.Martinez
DESIGNACIÓN:		
tribex 2p-1200x1200x400-estandar		

Nº PLANO:



This present document and its contents are confidential, and are the exclusive intellectual and / or industrial property of DELVALLE. In addition to any technology, design, invention, work, process, know-how, calculation, manual, method, solution, idea, improvement, drawing, diagram, modification, contribution and, in short, any associated information or documentation involving industrial or intellectual property developed or supplied by DELVALLE on the occasion of the quote, order execution or incorporated into the design or operation of the supply. The recipient may not use such property in his favour or in that of a third party for purposes other than the fulfilment of the order and the operation and maintenance of the supply, without the prior written consent of DELVALLE. It is strictly forbidden to totally or partially reproduce this document and to misuse it and / or to show it to third parties. The infringing parties shall be required to pay the corresponding compensation for damages, and any other legal or criminal responsibility if the infringement may give rise to.

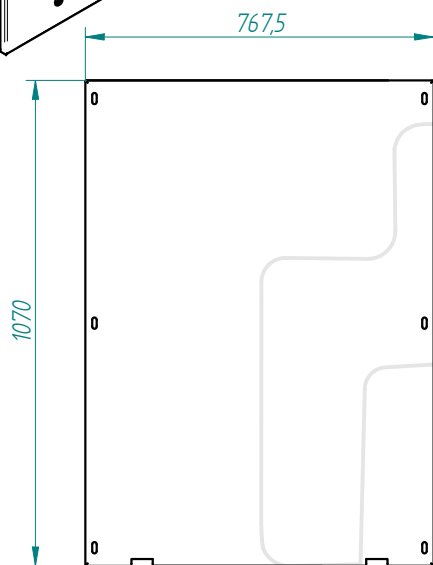
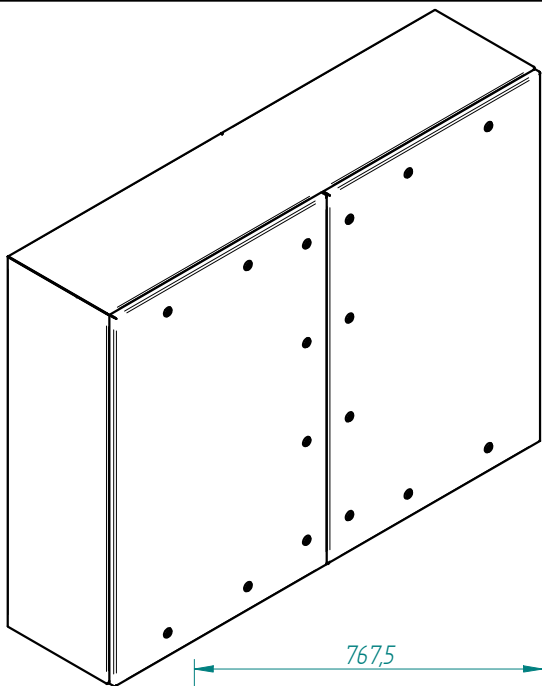

2 PLACAS

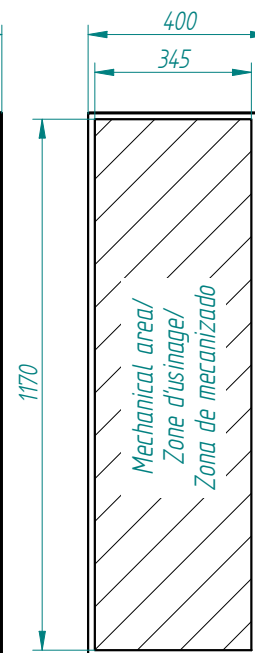
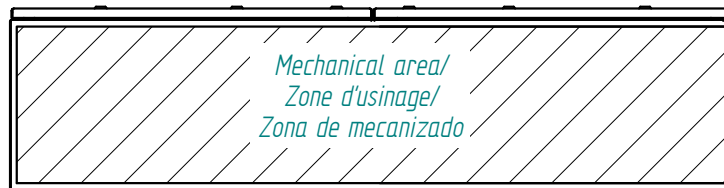
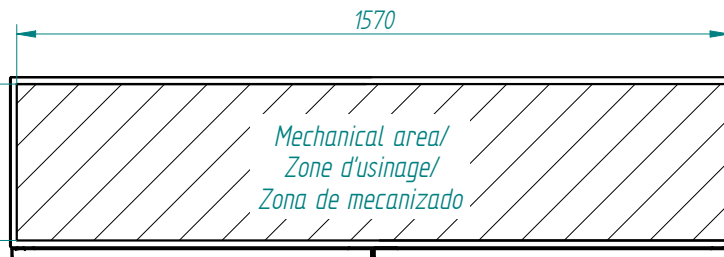
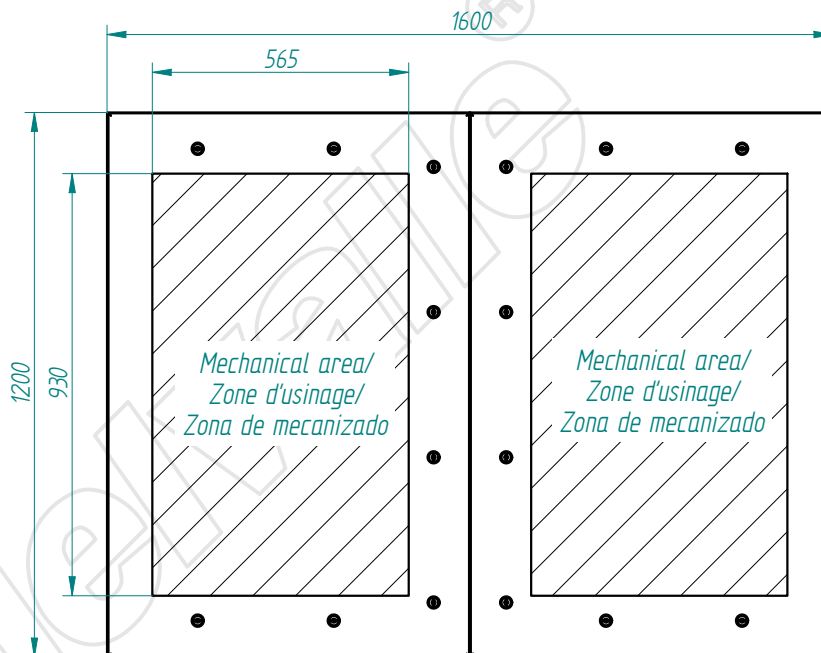

TOLERANCIA GENERAL DE MECANIZACION segun DIN 7168					Referencia:		FECHA:	FIRMA:	
						DIBUJADO:	28/04/2015	D.Martinez	
							APROBADO:	28/04/2015	D.Martinez
	Creación del documento	28/04/2015	D.MTNEZ	A	-	DESIGNACIÓN:			Nº PLANO:
	MODIFICACIONES	FECHA:	FIRMA:	REVISIÓN:	plegado: acabado:	tribex 2p-1200x16000x400-estandar			



This present document and its contents are confidential, and are the exclusive intellectual and / or industrial property of DELVALLE. In addition to any technology, design, invention, work, process, know-how, calculation, manual, method, solution, idea, improvement, drawing, modification, contribution and, in short, any associated information or documentation involving industrial or intellectual property developed or supplied by DELVALLE on the occasion of the quote, order execution or incorporated into the design or operation of the supply. The recipient may not use such property in his favour or in that of a third party for purposes other than the fulfilment of the order and the operation and maintenance of the supply, without the prior written consent of DELVALLE. It is strictly forbidden to totally or partially reproduce this document and to misuse it and / or to show it to third parties. The infringing parties shall be required to pay the corresponding compensation for damages, and any other legal or criminal responsibility is the infringement may give rise to.

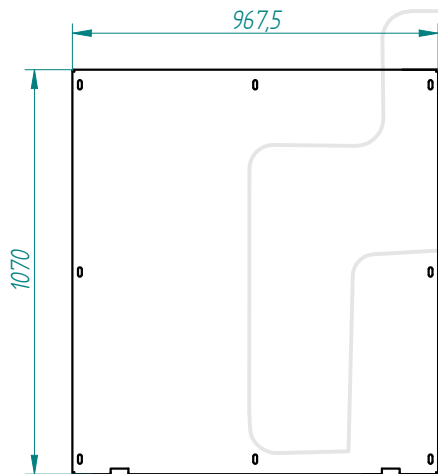
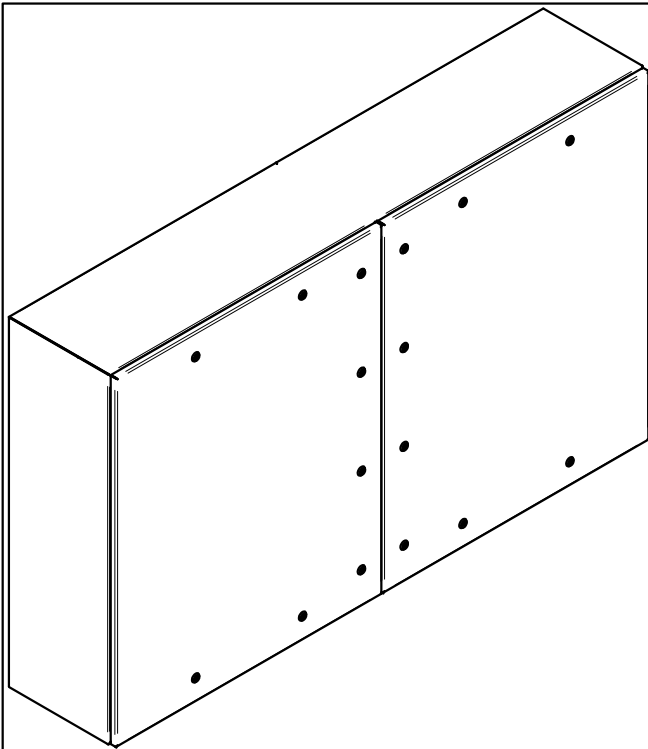

2 PLACAS

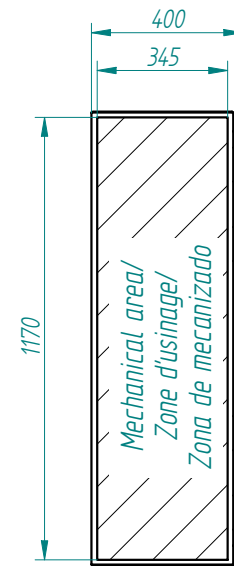
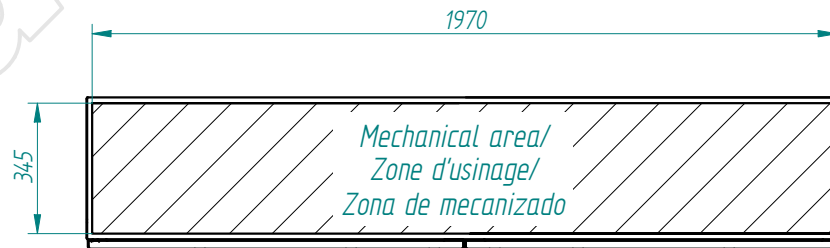
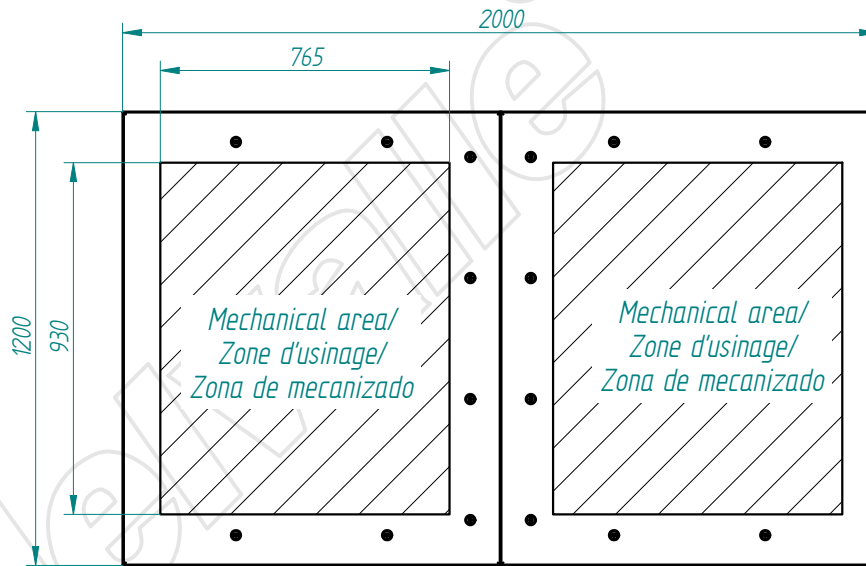

TOLERANCIA GENERAL DE MECANIZACION segun DIN 7168	Creación del documento	28/04/2015	D.MTNEZ	A	Referencia: - plegado: - acabado:	DIBUJADO:	28/04/2015	FIRMA:	D.Martinez	 Nº PLANO:
	MODIFICACIONES	FECHA:	FIRMA:	REVISIÓN:		APROBADO:	28/04/2015	D.Martinez		
	DESIGNACIÓN: tribex 2p-1200x2000x400-estandar									



This present document and its contents are confidential, and are the exclusive intellectual and / or industrial property of DELVALLE. In addition to any technology, design, invention, work, process, know-how, calculation, manual, method, solution, idea, improvement, drawing, modification, contribution and, in short, any associated information involving industrial or intellectual property developed or supplied by DELVALLE on the occasion of the quote, order execution or incorporated into the design or operation of the supply. The recipient may not use such property in his favour or in that of a third party for purposes other than the fulfilment of the order and the operation and maintenance of the supply, without the prior written consent of DELVALLE. It is strictly forbidden to totally or partially reproduce this document and to misuse it and / or to show it to third parties. The infringing parties shall be required to pay the corresponding compensation for damages, and any other legal or criminal, responsible and the infringement may give rise to.

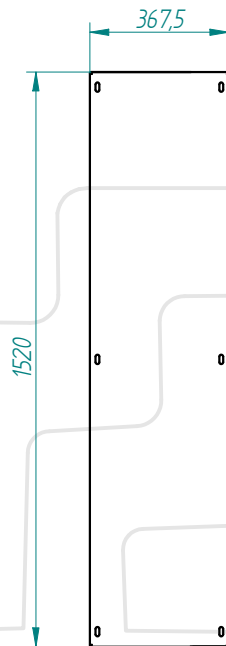
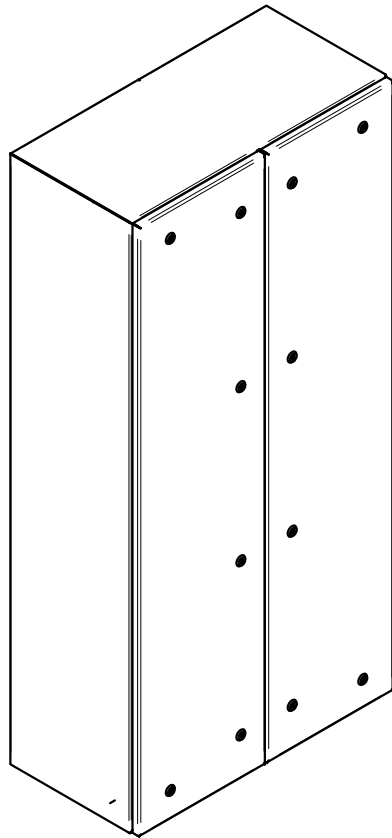

2 PLACAS

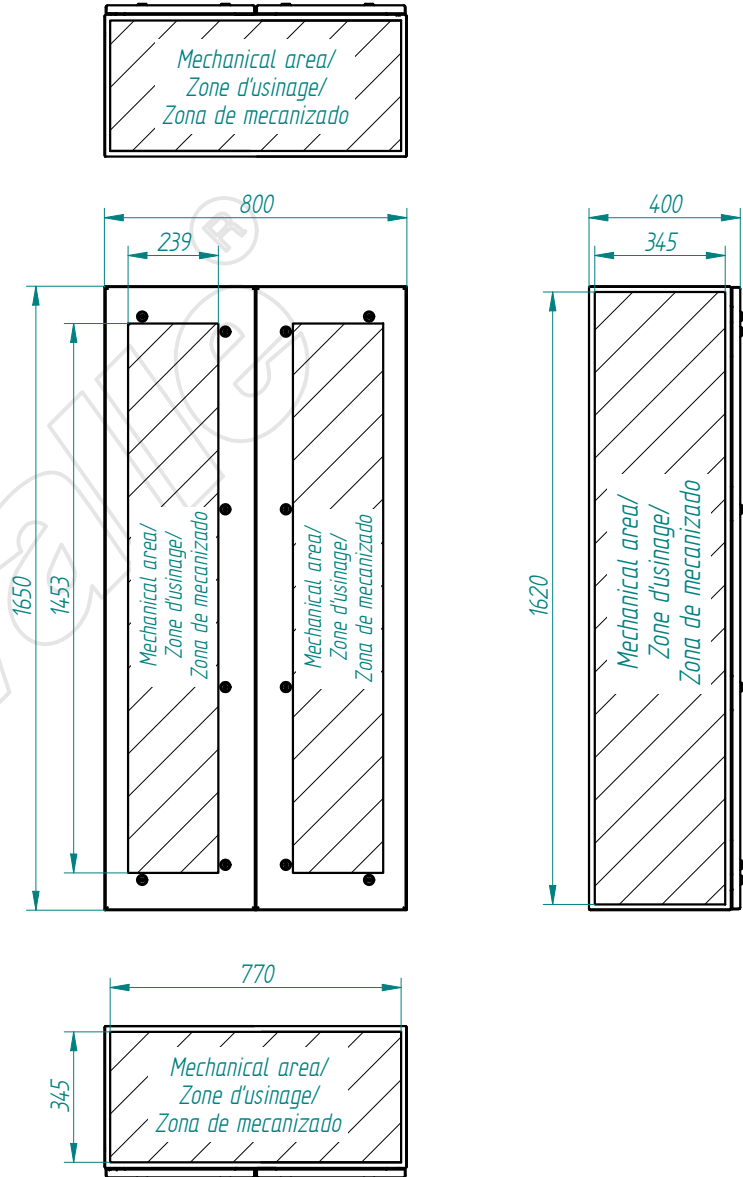

TOLERANCIA GENERAL DE MECANIZACION según DIN 7168					Referencia:		FECHA:	FIRMA:	
						DIBUJADO:	28/04/2015	D.Martínez	
						APROBADO:	28/04/2015	D.Martínez	
	Creación del documento	28/04/2015	D.MTNEZ	A	-	DESIGNACIÓN:			Nº PLANO:
	MODIFICACIONES	FECHA:	FIRMA:	REVISIÓN:	plegado: acabado:	tribex 2p-1650x800x400-estandar			



This present document and its contents are confidential, and are the exclusive intellectual and / or industrial property of DELVALLE. In addition to any technology, design, invention, work, process, know-how, calculation, manual, method, solution, idea, improvement, drawing, diagram, modification, contribution and, in short, any associated information involving industrial or intellectual property developed or supplied by DELVALLE on the occasion of the quote, order execution or incorporated into the design or operation of the supply. The recipient may not use such property in his favour or in that of a third party for purposes other than the fulfilment of the order and the operation and maintenance of the supply, without the prior written consent of DELVALLE. It is strictly forbidden to totally or partially reproduce this document and to misuse it and / or to show it to third parties. The infringing parties shall be required to pay the corresponding compensation for damages, and any other legal or criminal, responsible and the infringement may give rise to.

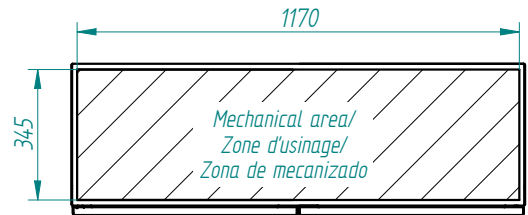
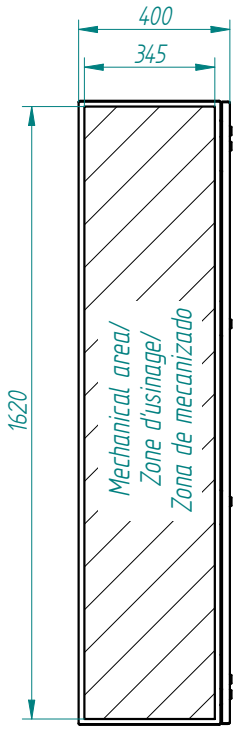
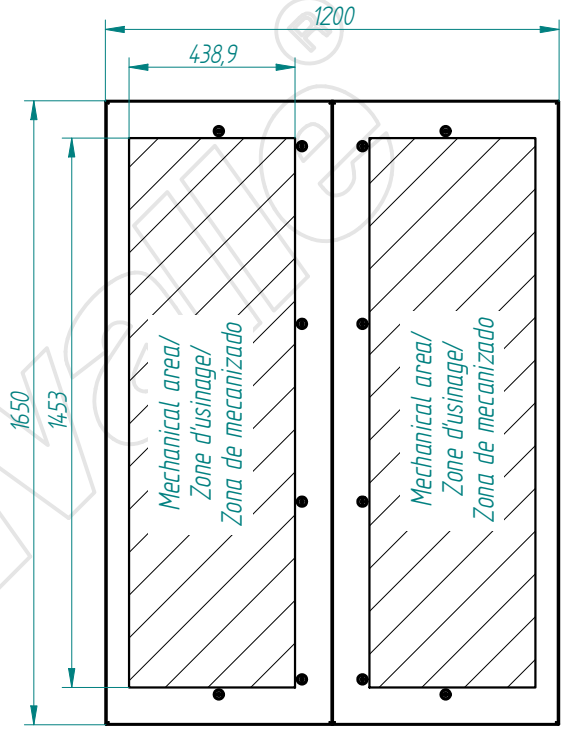
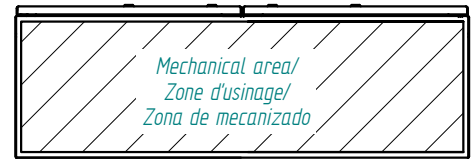
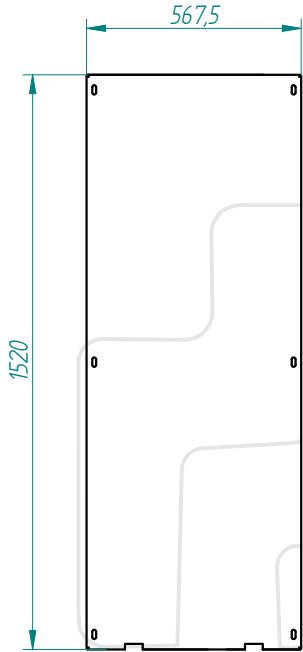
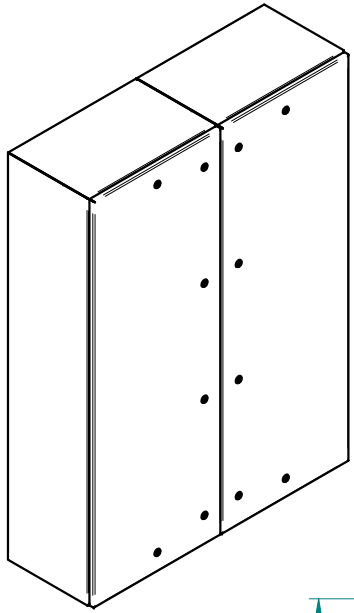

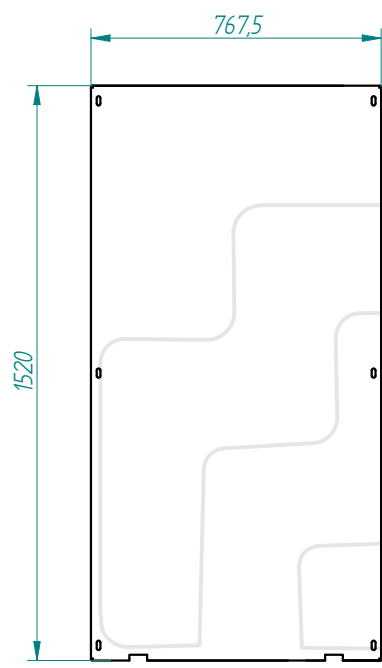
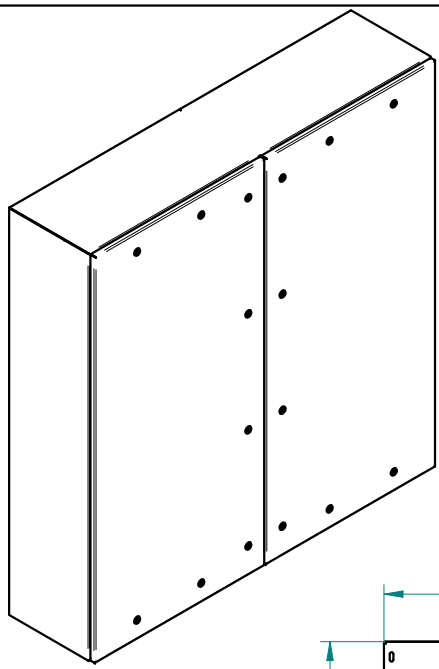

TOLERANCIA GENERAL DE MECANIZACION segun DIN 7168	Creación del documento	28/04/2015	D.MTNEZ	A	Referencia: - plegado: acabado.	DIBUJADO:	28/04/2015	FIRMA:	D.Martinez	 N° PLANO:
	MODIFICACIONES	FECHA:	FIRMA:	REVISIÓN:		APROBADO:	28/04/2015	D.Martinez		
	DESIGNACIÓN: tribex 2p-1650x1200x400-estandar									

This present document and its contents are confidential, and are the exclusive intellectual and / or industrial property of DELVALLE. In addition to any technology, design, invention, work, process, know-how, calculation, manual, method, solution, idea, improvement, drawing, diagram, modification, contribution and, in short, any associated information or documentation involving industrial or intellectual property developed or supplied by DELVALLE on the occasion of the quote, order execution or incorporated into the design or operation of the supply. The recipient may not use such property in his favour or in that of a third party for purposes other than the fulfilment of the order and the operation and maintenance of the supply, without the prior written consent of DELVALLE. It is strictly forbidden to totally or partially reproduce this document and to misuse it and / or to show it to third parties. The infringing parties shall be required to pay the corresponding compensation for damages, and any other legal or criminal responsibility is the infringer's sole responsibility.

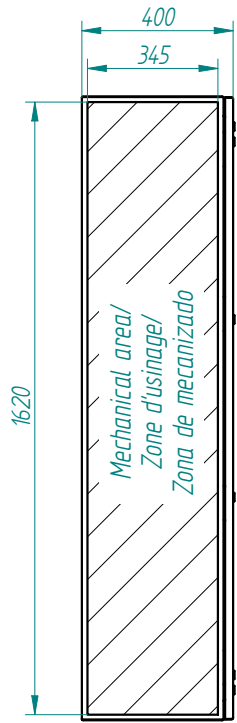
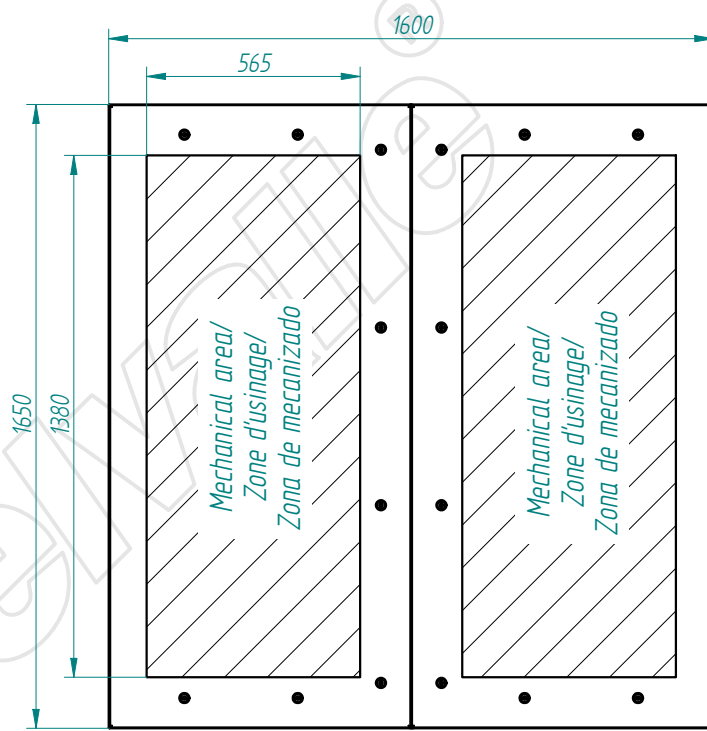
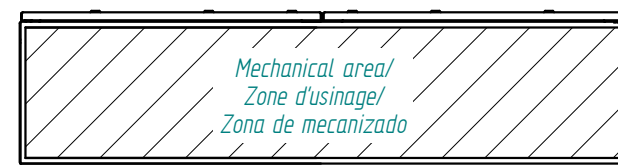

2 PLACAS



TOLERANCIA GENERAL DE MECANIZACION segun DIN 7168					Referencia: - plegado: - acabado:	DIBUJADO:	FECHA:	FIRMA:	 Nº PLANO:
						APROBADO:	28/04/2015	D.Martinez	
	Creación del documento	28/04/2015	D.MTNEZ	A		DESIGNACIÓN:	tribex 2p-1650x1600x400-estandar		
	MODIFICACIONES	FECHA:	FIRMA:	REVISIÓN:					

This present document and its contents are confidential, and are the exclusive intellectual and / or industrial property of DELVALLE. In addition to any technology, design, invention, work, process, know-how, calculation, manual, method, solution, idea, improvement, drawing, diagram, modification, contribution and, in short, any associated information or documentation involving industrial or intellectual property developed or supplied by DELVALLE on the occasion of the quote, order execution or incorporated into the design or operation of the supply. The recipient may not use such property in his favour or in that of a third party for purposes other than the fulfilment of the order and the operation and maintenance of the supply, without the prior written consent of DELVALLE. It is strictly forbidden to totally or partially reproduce this document and to misuse it and / or to show it to third parties. The infringing parties shall be required to pay the corresponding compensation for damages, and any other legal or criminal, responsible and the infringement may give rise to.

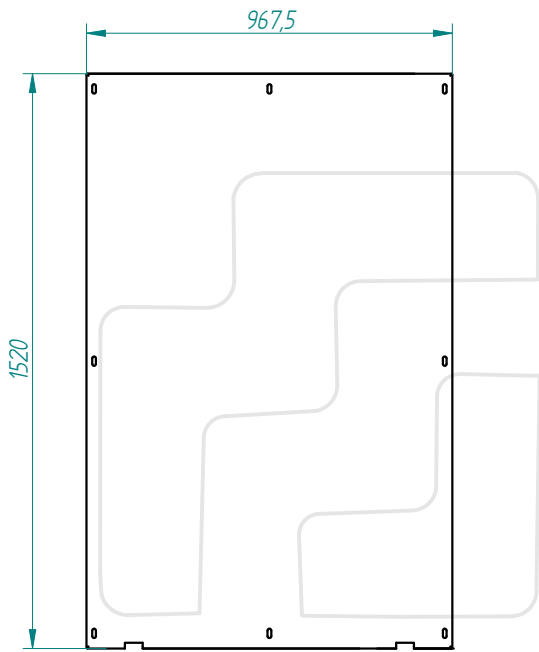
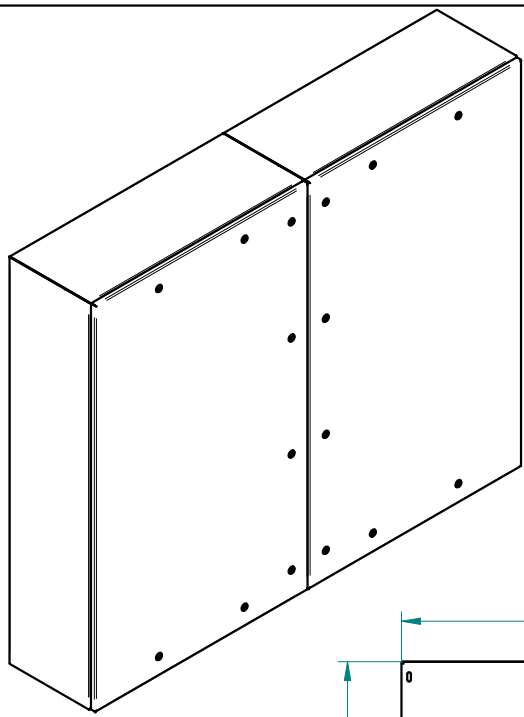

2 PLACAS

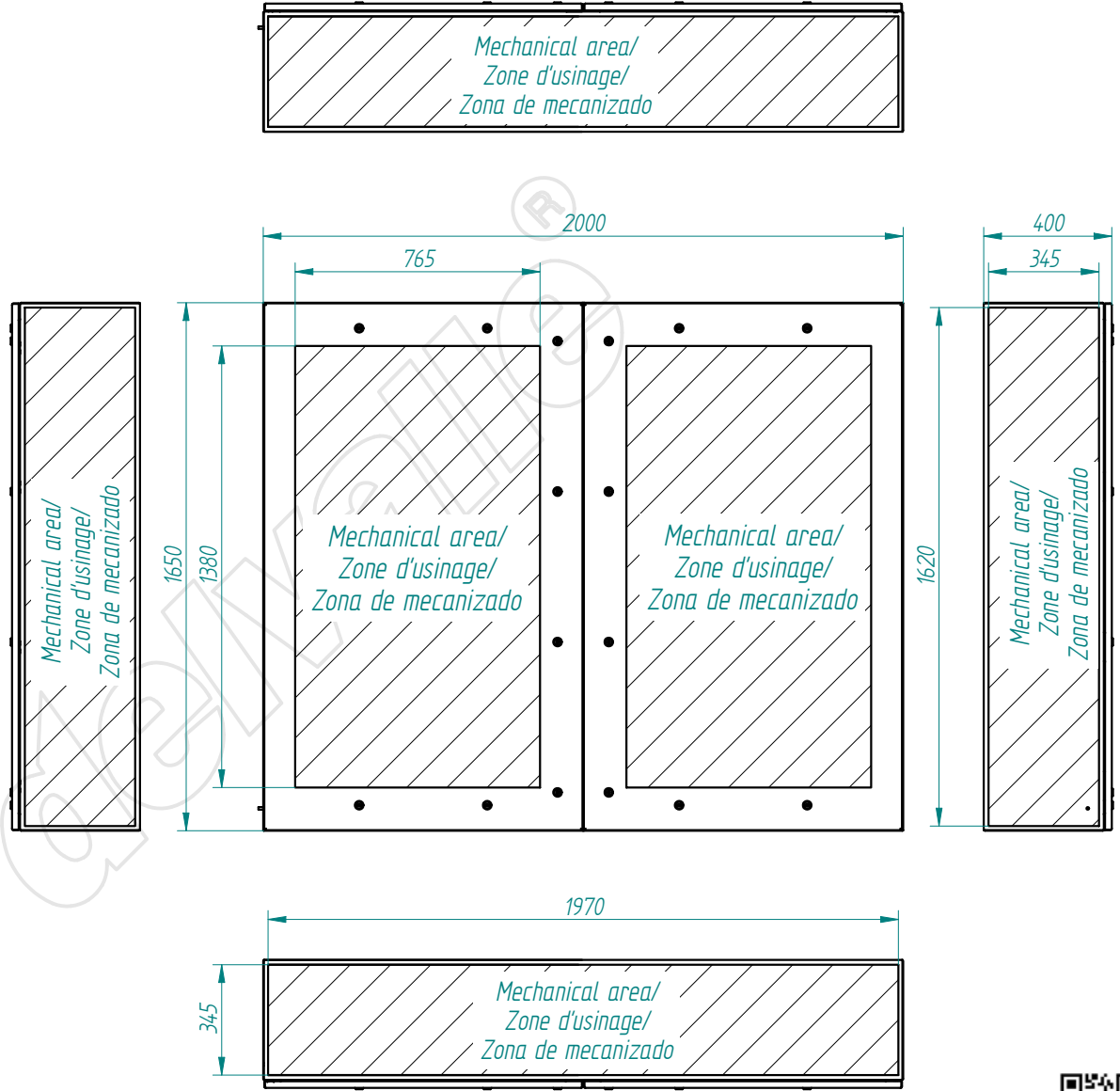



TOLERANCIA GENERAL DE MECANIZACION según DIN 7168					
	Creación del documento	28/04/2015	D.MTNEZ	A	-
	MODIFICACIONES	FECHA:	FIRMA:	REVISIÓN:	plegado: acabado:

Referencia:	DIBUJADO:	28/04/2015	FIRMA:	D.Martínez
	APROBADO:	28/04/2015	FIRMA:	D.Martínez
DESIGNACIÓN:				Nº PLANO:
tribex 2p-1650x2000x400-estandar				



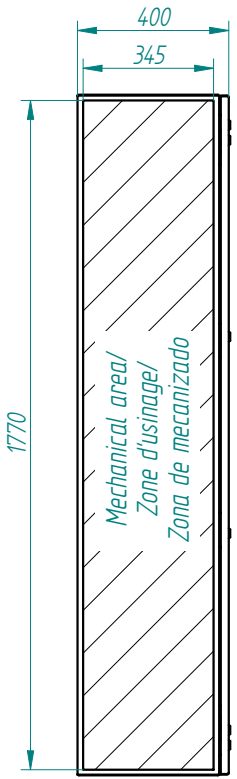
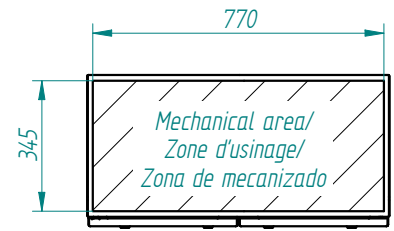
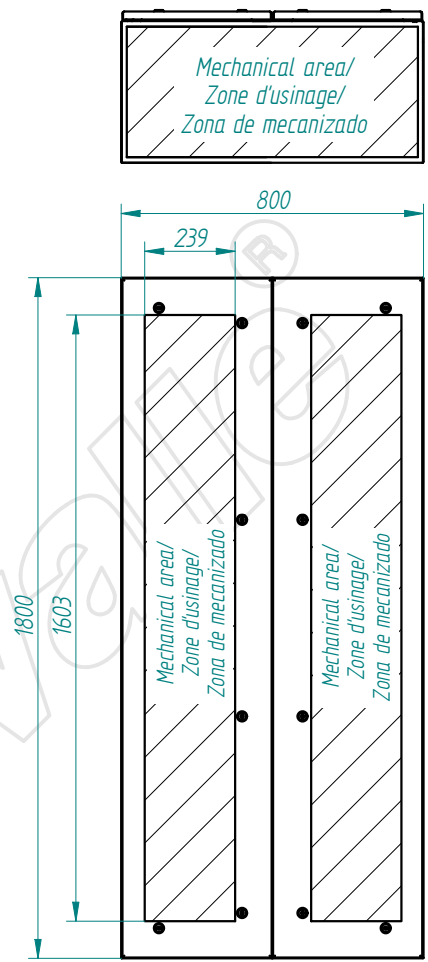
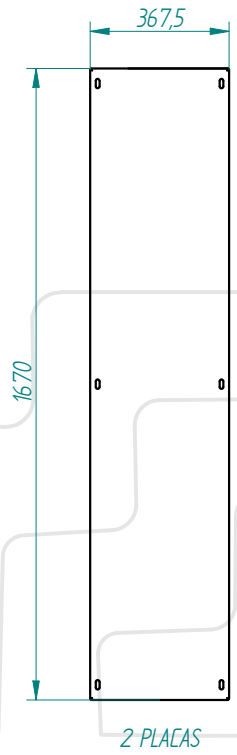
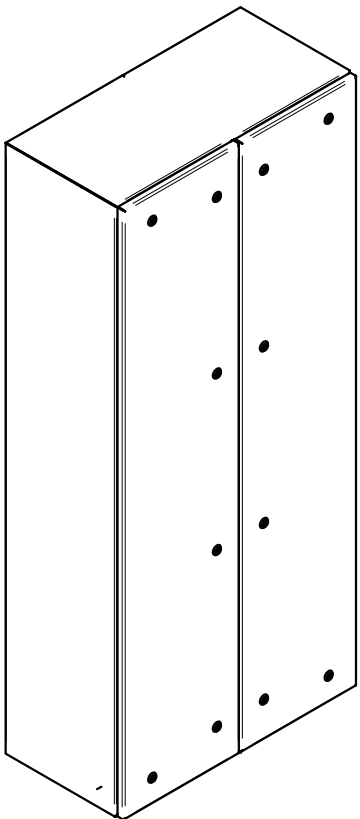

This present document and its contents are confidential, and are the exclusive intellectual and / or industrial property of DELVALLE. In addition to any technology, design, invention, work, process, know-how, calculation, manual, method, solution, idea, improvement, drawing, diagram, modification, contribution and, in short, any associated information or documentation involving industrial or intellectual property developed or supplied by DELVALLE on the occasion of the quote, order execution or incorporated into the design or operation of the supply. The recipient may not use such property in his favour or in that of a third party for purposes other than the fulfilment of the order and the operation and maintenance of the supply, without the prior written consent of DELVALLE. It is strictly forbidden to totally or partially reproduce this document and to misuse it or to show it to third parties. The infringing parties shall be required to pay the corresponding compensation for damages, and any other legal or criminal responsibility is the infringement may give rise to.

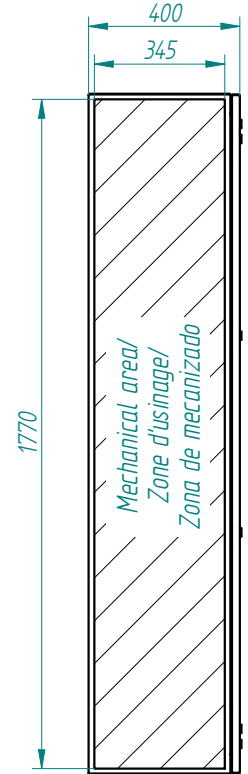
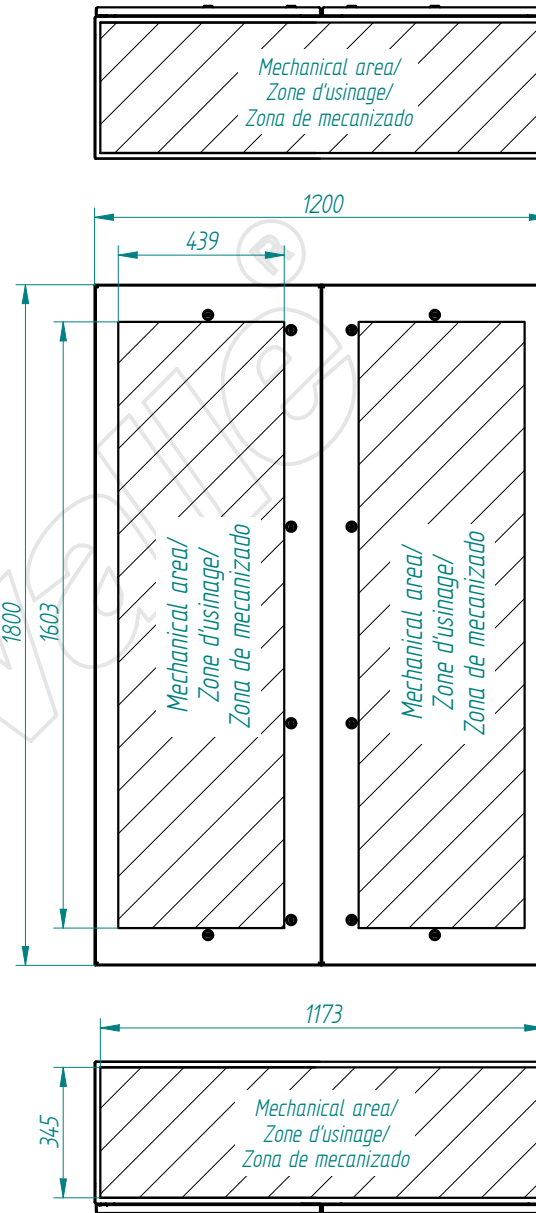
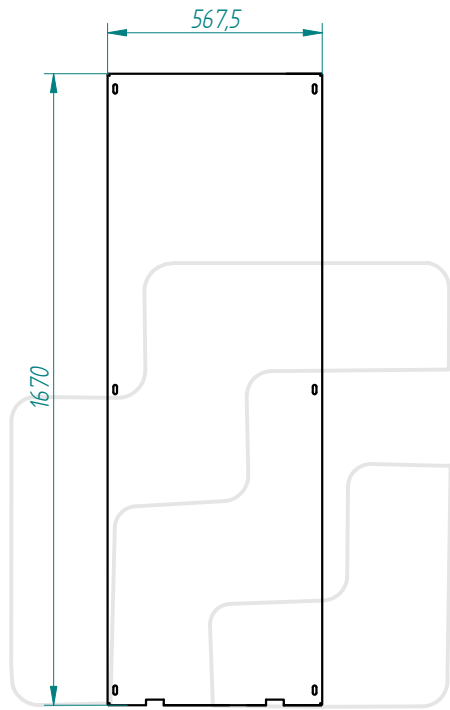
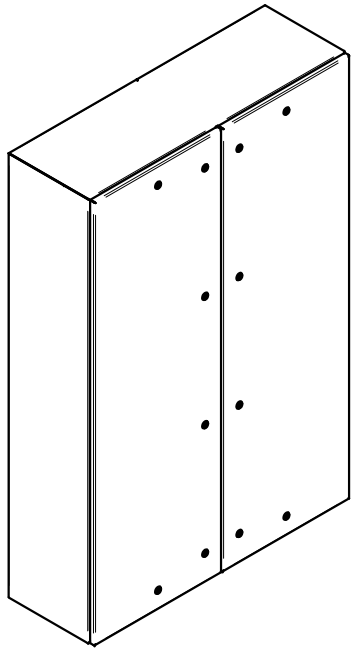

TOLERANCIA GENERAL DE MECANIZACION según DIN 7168					Referencia:	DIBUJADO:	FECHA:	FIRMA:	
						APROBADO:	28/04/2015	D.Martínez	
	Creación del documento	28/04/2015	D.MTNEZ	A	-	DESIGNACIÓN:			Nº PLANO:
	MODIFICACIONES	FECHA:	FIRMA:	REVISIÓN:	plegado: acabado:	tribex 2p-1800x800x400-estandar			

This present document and its contents are confidential, and are the exclusive intellectual and / or industrial property of DELVALLE. In addition to any technology, design, invention, work, process, know-how, calculation, manual, method, solution, idea, improvement, drawing, diagram, modification, contribution and, in short, any associated information or documentation involving industrial or intellectual property developed or supplied by DELVALLE on the occasion of the quote, order execution or incorporated into the design or operation of the supply. The recipient may not use such property in his favour or in that of a third party for purposes other than the fulfilment of the order and the operation and maintenance of the supply, without the prior written consent of DELVALLE. It is strictly forbidden to totally or partially reproduce this document and to misuse it or to show it to third parties. The infringing parties shall be required to pay the corresponding compensation for damages, and any other legal or criminal responsibility is the infringement may give rise to.



TOLERANCIA GENERAL DE MECANIZACION según DIN 7168					Referencia: - plegado: acabado:	DIBUJADO:	FECHA:	FIRMA:	 Nº PLANO:
						APROBADO:	28/04/2015	D.Martínez	
	Creación del documento	28/04/2015	D.MTNEZ	A		DESIGNACIÓN:	28/04/2015	D.Martínez	
	MODIFICACIONES	FECHA:	FIRMA:	REVISIÓN:		tribex 2p-1800x1200x400-estandar			

This present document and its contents are confidential, and are the exclusive intellectual and / or industrial property of DEVALLE. In addition to any technology, design, invention, work, process, know-how, calculation, manual, solution, idea, improvement, drawing, diagram, modification, contribution and, in short, any associated information or documentation involving industrial or intellectual property developed or supplied by DEVALLE on the occasion of the quote, order execution or incorporated into the design or operation of the supply. The recipient may not use such property in his favour or in that of a third party for purposes other than the fulfilment of the order and the operation and maintenance of the supply, without the prior written consent of DEVALLE. It is strictly forbidden to totally or partially reproduce this document and to misuse it and / or to show it to third parties. The infringing parties shall be required to pay the corresponding compensation for damages, and any other legal or criminal responsibility is the infringement may give rise to.

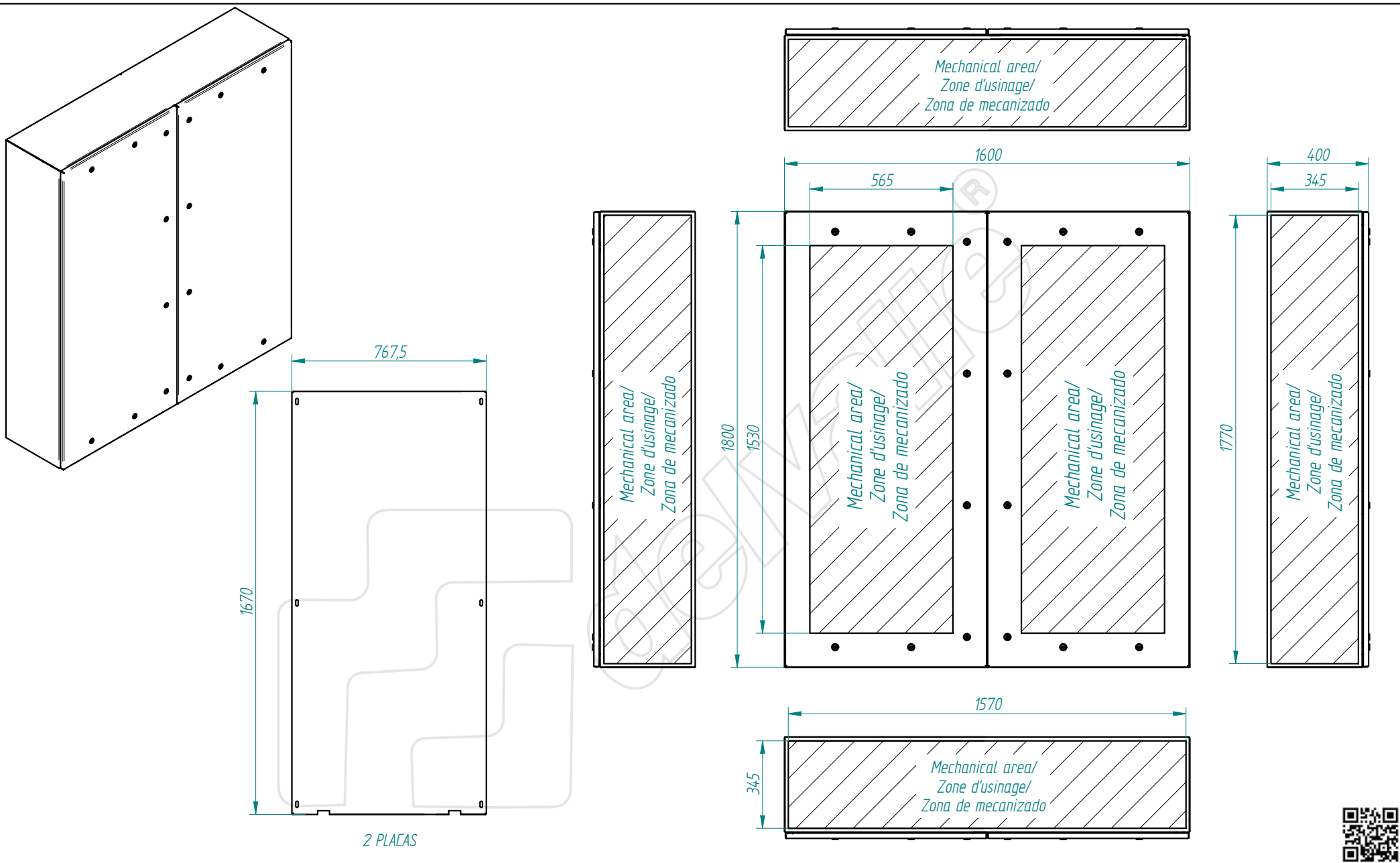

TOLERANCIA GENERAL DE MECANIZACION segun DIN 7168					Referencia: - plegado: - acabado:	DIBUJADO:	FECHA:	FIRMA:	 Nº PLANO:
						APROBADO:	28/04/2015	D.Martinez	
	Creación del documento	28/04/2015	D.MTNEZ	A		DESIGNACIÓN:	tribex 2p-1800x1600x400-estandar		
	MODIFICACIONES	FECHA:	FIRMA:	REVISIÓN:					



This present document and its contents are confidential, and are the exclusive intellectual and / or industrial property of DELVALLE ., in addition to any technology, design, invention, work, process, know-how, calculation, manual, method, solution, idea, improvement, drawing, diagram, modification, contribution and, in short, any associated information involving industrial or intellectual property developed or supplied by DELVALLE on the occasion of the quote, order execution or incorporated into the design or operation of the supply. The recipient may not use such property in his favour or in that of a third party for purposes other than the fulfilment of the order and the operation and maintenance of the supply, without the prior written consent of DELVALLE. It is strictly forbidden to totally or partially reproduce this document and to misuse it and / or to show it to third parties. The infringing parties shall be required to pay the corresponding compensation for damages, and any other legal or criminal, responsible and the infringement may give rise to.

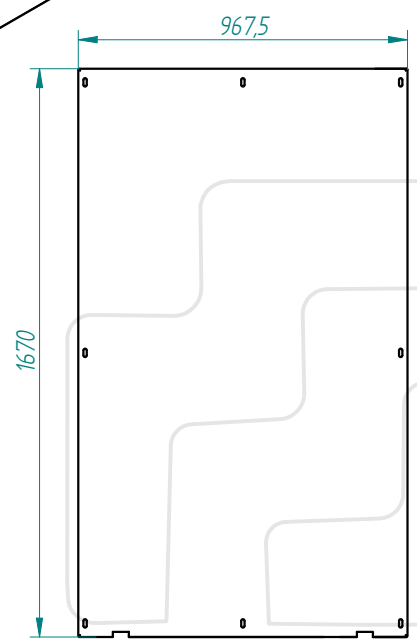
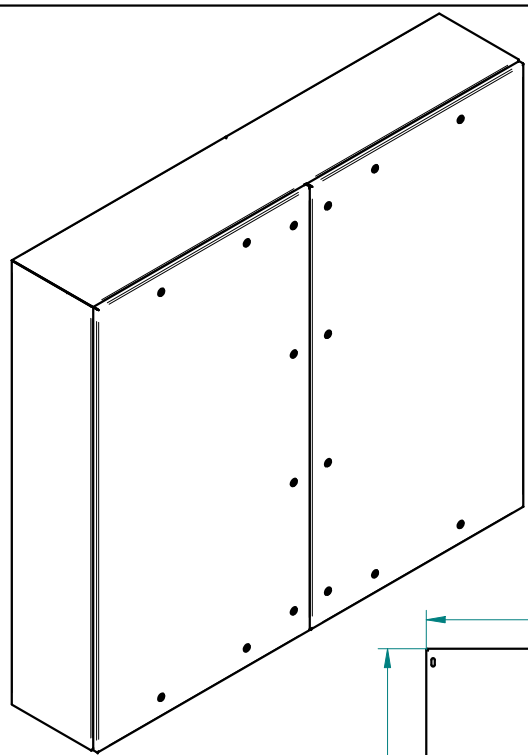

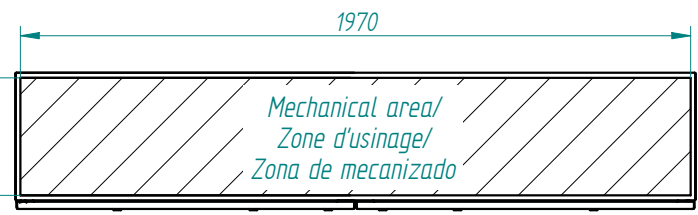
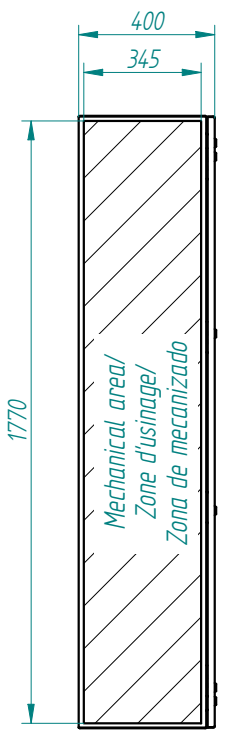
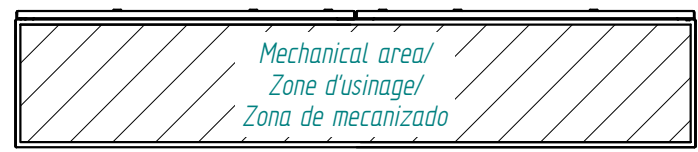
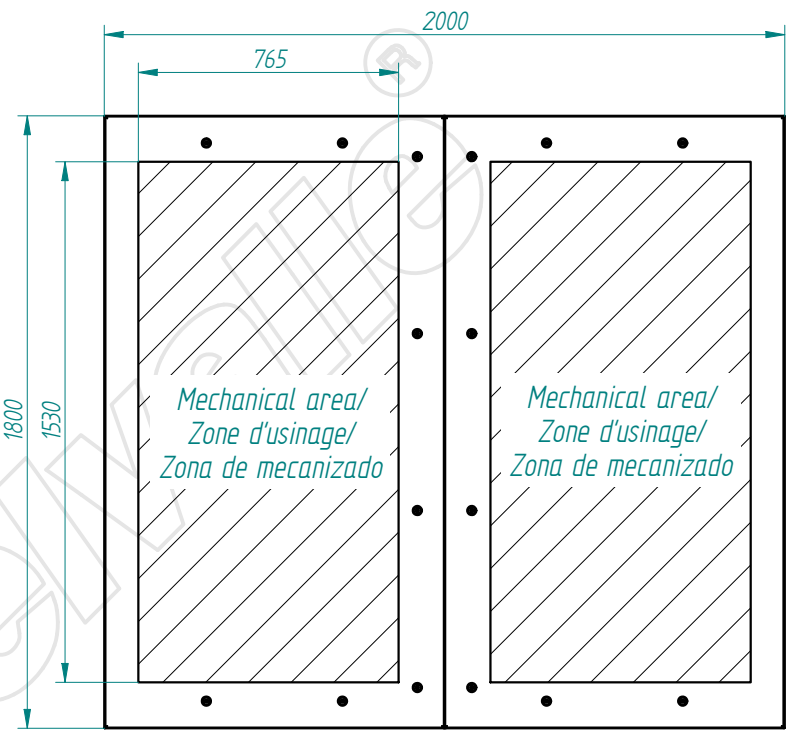
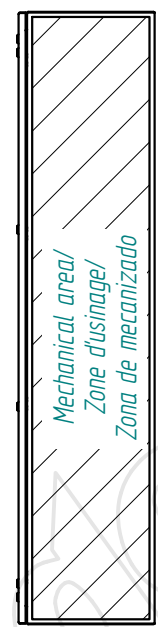

2 PLACAS

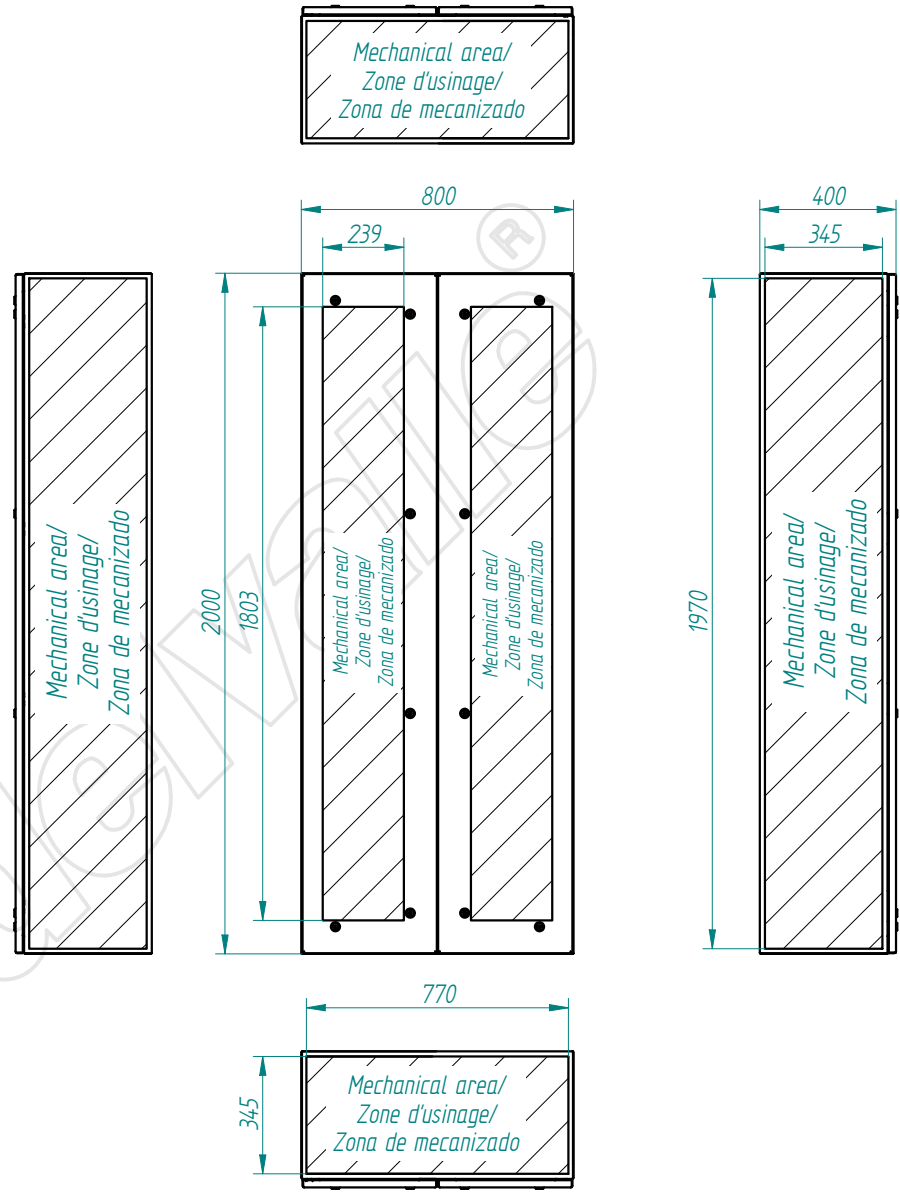
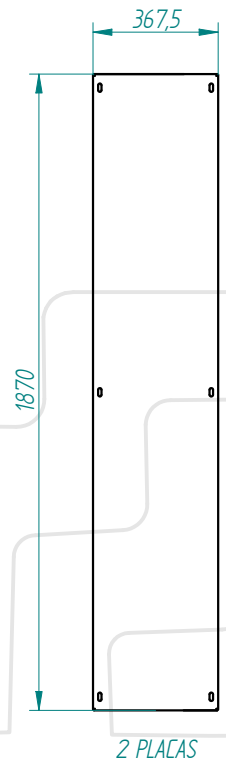
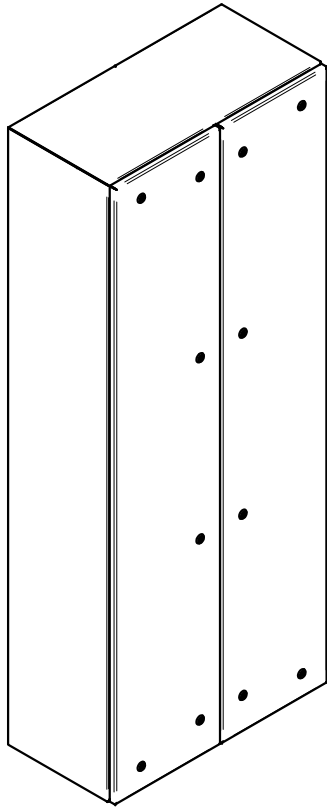

TOLERANCIA GENERAL DE MECANIZACION segun DIN 7168					Referencia:	DIBUJADO:	28/04/2015	FIRMA:	D.Martinez	
						APROBADO:	28/04/2015	FIRMA:	D.Martinez	
	Creación del documento	28/04/2015	D.MTNEZ	A	-	DESIGNACIÓN:			Nº PLANO:	
	MODIFICACIONES	FECHA:	FIRMA:	REVISIÓN:	plegado: acabado:	tribex 2p-1800x2000x400-estandar				

This present document and its contents are confidential, and are the exclusive intellectual and / or industrial property of DELVALLE. In addition to any technology, design, invention, work, process, know-how, calculation, manual, method, solution, idea, improvement, drawing, diagram, modification, contribution and, in short, any associated information or documentation involving industrial or intellectual property developed or supplied by DELVALLE on the occasion of the quote, order execution or incorporated into the design or operation of the supply. The recipient may not use such property in his favour or in that of a third party for purposes other than the fulfilment of the order and the operation and maintenance of the supply, without the prior written consent of DELVALLE. It is strictly forbidden to totally or partially reproduce this document and to misuse it and / or to show it to third parties. The infringing parties shall be required to pay the corresponding compensation for damages, and any other legal or criminal responsibility is the infringement may give rise to.



TOLERANCIA GENERAL DE MECANIZACION según DIN 7168	Creación del documento	28/04/2015	D.MTNEZ	A	Referencia: - plegado: - acabado:	DIBUJADO:	FECHA:	FIRMA:	 Nº PLANO:
	MODIFICACIONES	FECHA:	FIRMA:	REVISIÓN:		APROBADO:	28/04/2015	D.Martínez	
DESIGNACIÓN:						tribex 2p-2000x800x400-estandar			



This present document and its contents are confidential, and are the exclusive intellectual and / or industrial property of DELVALLE. In addition to any technology, design, invention, work, process, know-how, calculation, manual, method, solution, idea, improvement, drawing, diagram, modification, contribution and, in short, any associated information or documentation involving industrial or intellectual property developed or supplied by DELVALLE on the occasion of the quote, order execution or incorporated into the design or operation of the supply. The recipient may not use such property in his favour or in that of a third party for purposes other than the fulfilment of the order and the operation and maintenance of the supply, without the prior written consent of DELVALLE. It is strictly forbidden to totally or partially reproduce this document and to misuse it and / or to show it to third parties. The infringing parties shall be required to pay the corresponding compensation for damages, and any other legal or criminal responsibility is the infringement may give rise to.

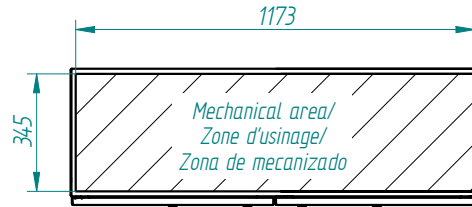
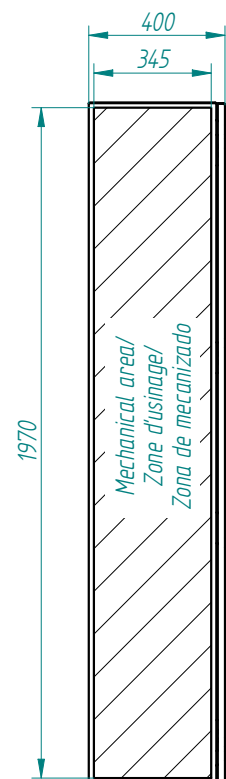
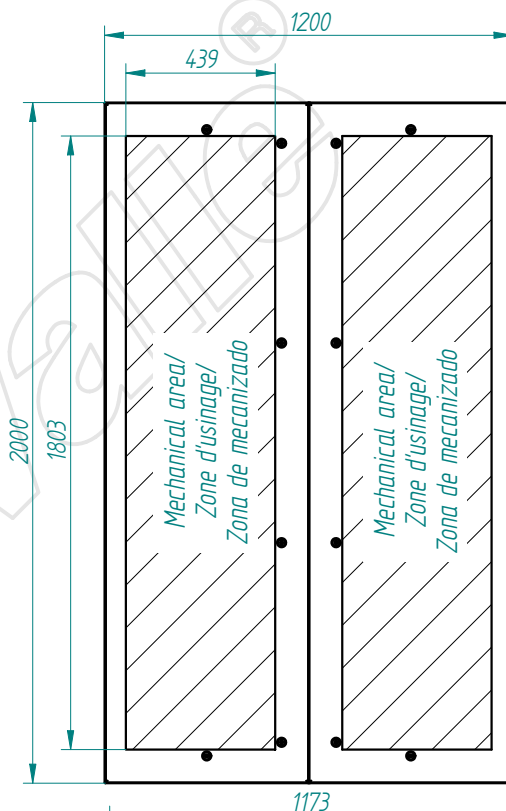
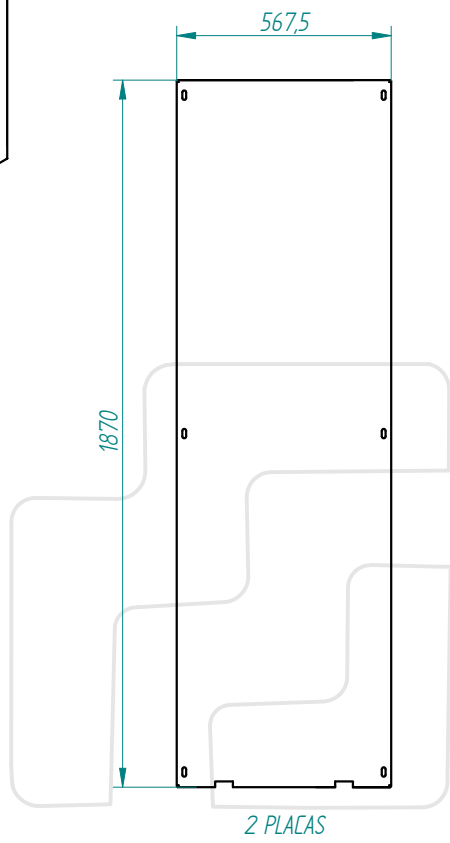
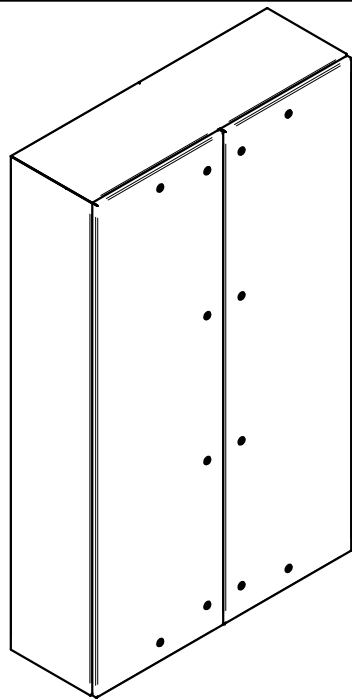

TOLERANCIA GENERAL DE MECANIZACION según DIN 7168	Creación del documento	28/04/2015	D.MTNEZ	A	Referencia: - plegado: acabado:
	MODIFICACIONES	FECHA:	FIRMA:	REVISIÓN:	

DIBUJADO:	FECHA:	FIRMA:
28/04/2015	28/04/2015	D.Martínez
APROBADO:	28/04/2015	D.Martínez
DESIGNACIÓN:		
tribex 2p-2000x1200x400-estandar		

Nº PLANO:



This present document and its contents are confidential, and are the exclusive intellectual and / or industrial property of DELVALLE ., in addition to any technology, design, invention, work, process, know-how, calculation, manual, method, solution, idea, improvement, drawing, diagram, modification, contribution and, in short, any associated information involving industrial or intellectual property developed or supplied by DELVALLE on the occasion of the quote, order execution or incorporated into the design or operation of the supply. The recipient may not use such property in his favour or in that of a third party for purposes other than the fulfilment of the order and the operation and maintenance of the supply, without the prior written consent of DELVALLE. It is strictly forbidden to totally or partially reproduce this document and to misuse it and / or to show it to third parties. The infringing parties shall be required to pay the corresponding compensation for damages, and any other legal or criminal responsibility is the infringement may give rise to.

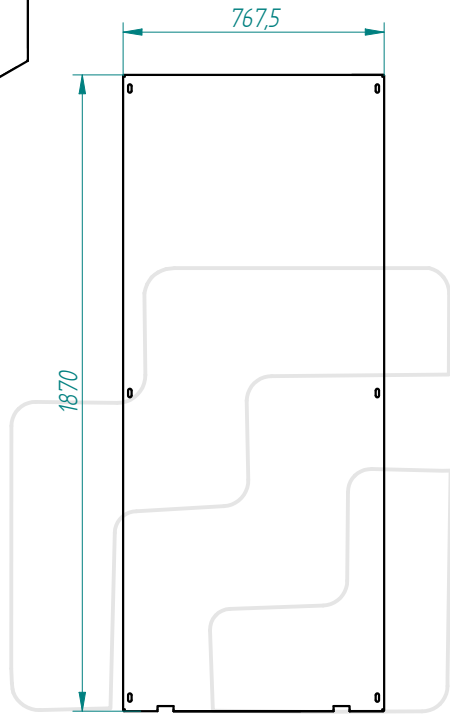
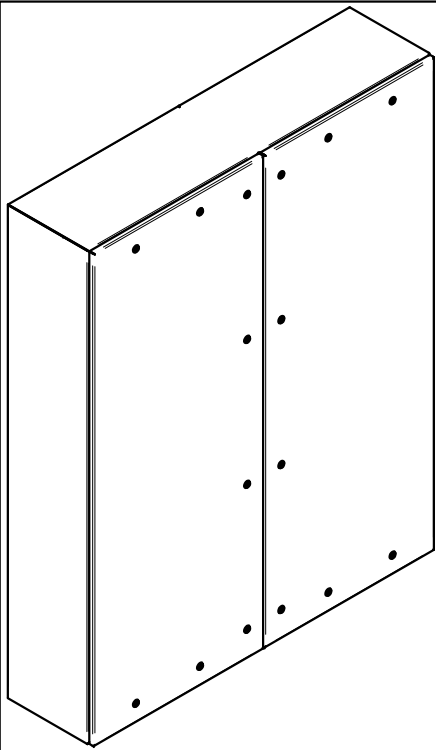

2 PLACAS

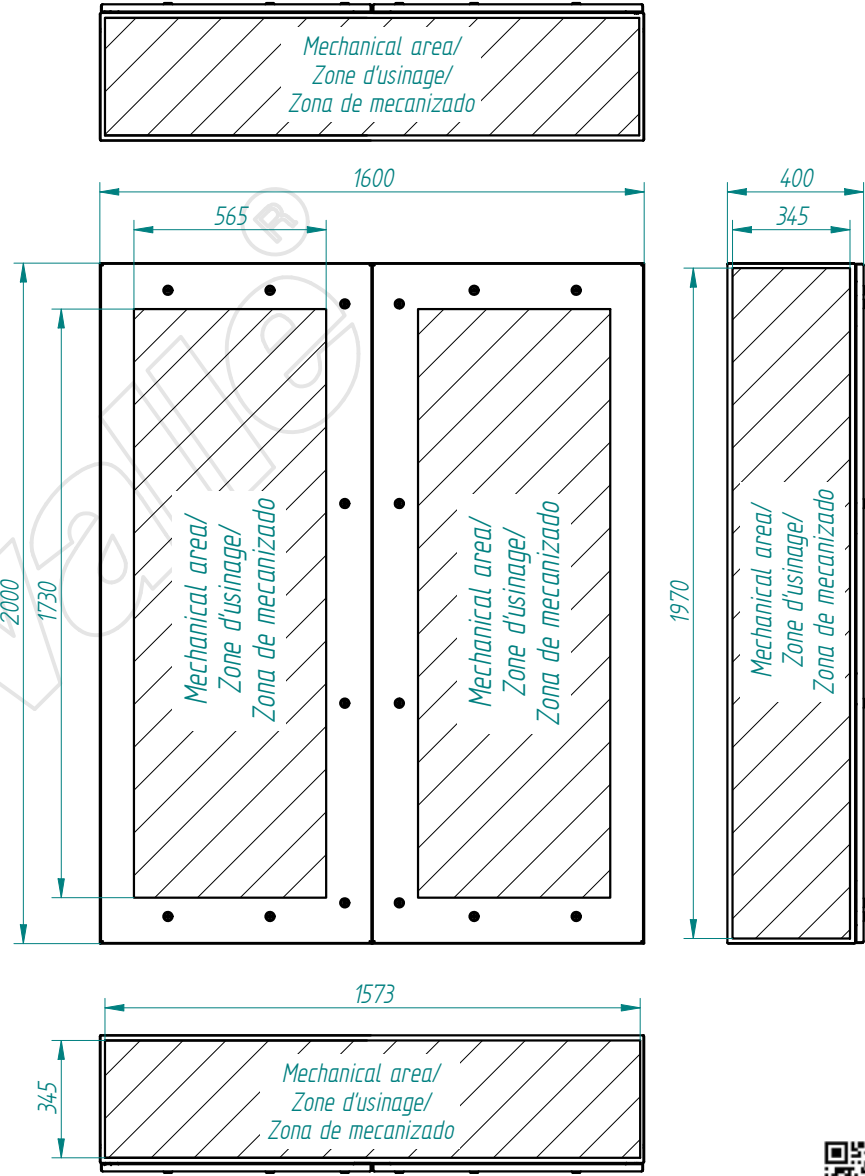

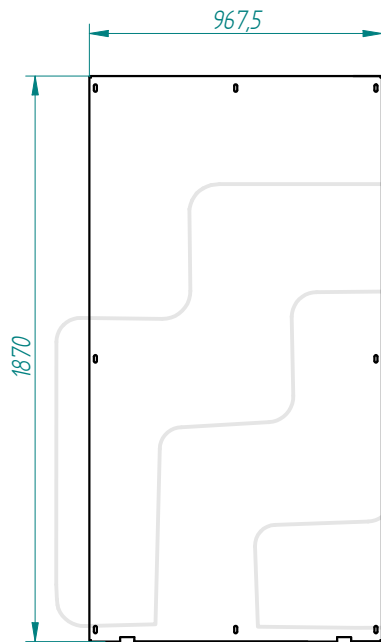
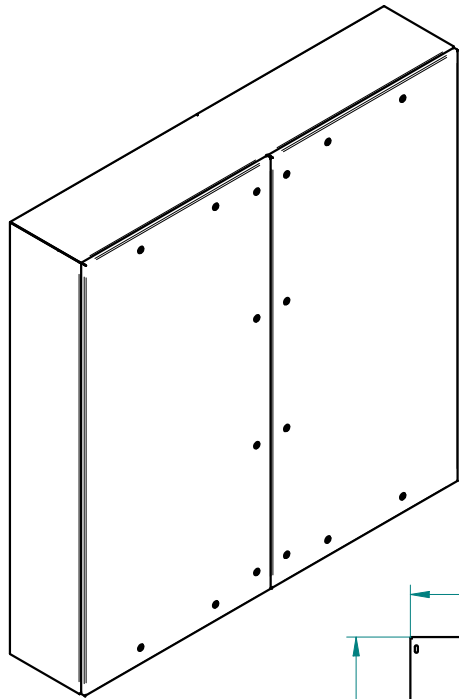

TOLERANCIA GENERAL DE MECANIZACION segun DIN 7168					Referencia:		FECHA:	FIRMA:	
							DIBUJADO: 28/04/2015	D.Martinez	
						APROBADO: 28/04/2015	D.Martinez		
	Creación del documento	28/04/2015	D.MTNEZ	A	-	DESIGNACIÓN:			Nº PLANO:
	MODIFICACIONES	FECHA:	FIRMA:	REVISIÓN:	plegado: acabado:	tribex 2p-2000x1600x400-estandar			

This present document and its contents are confidential, and are the exclusive intellectual and / or industrial property of DELVALLE. In addition to any technology, design, invention, work, process, know-how, calculation, manual, method, solution, idea, improvement, drawing, diagram, modification, contribution and, in short, any associated information or documentation involving industrial or intellectual property developed or supplied by DELVALLE on the occasion of the quote, order execution or incorporated into the design or operation of the supply. The recipient may not use such property in his favour or in that of a third party for purposes other than the fulfilment of the order and the operation and maintenance of the supply, without the prior written consent of DELVALLE. It is strictly forbidden to totally or partially reproduce this document and to misuse it and / or to show it to third parties. The infringing parties shall be required to pay the corresponding compensation for damages, and any other legal or criminal responsibility is the infringement may give rise to.

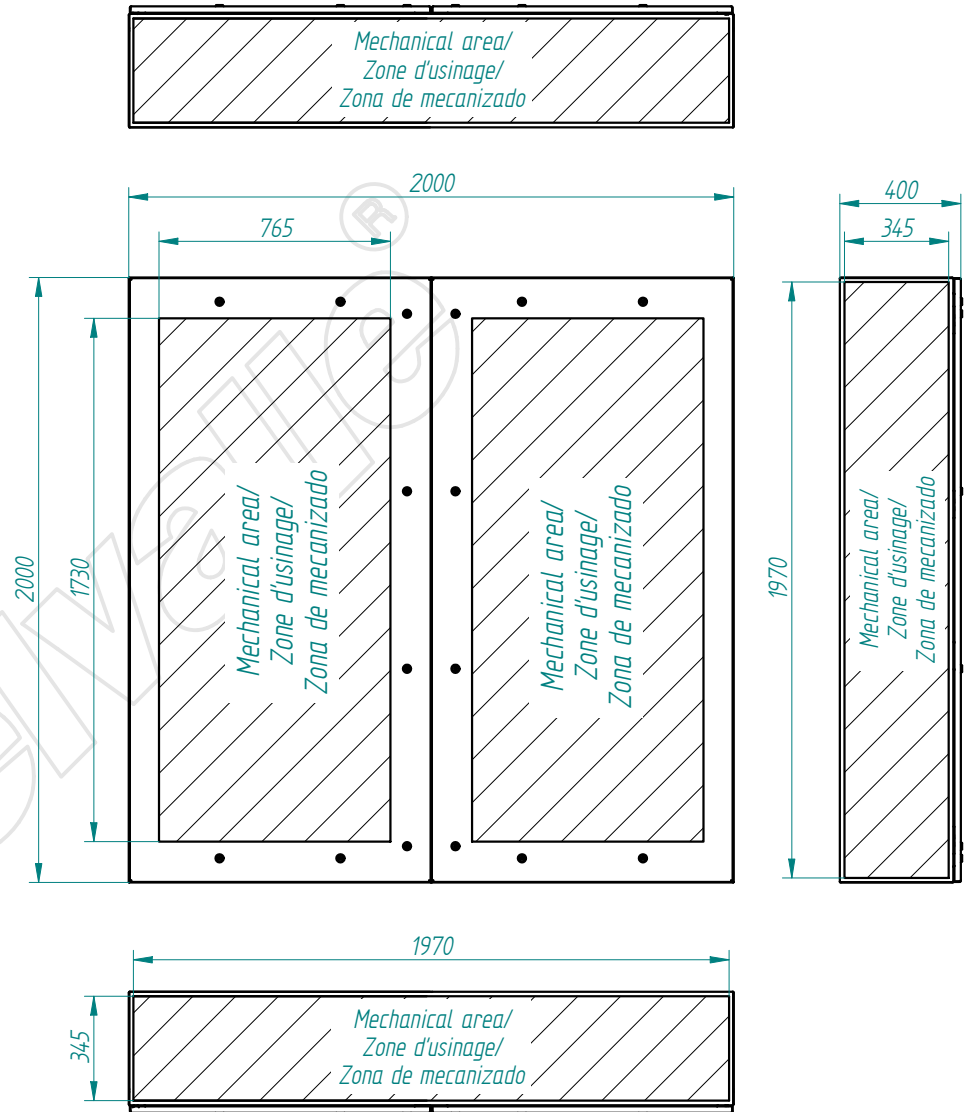
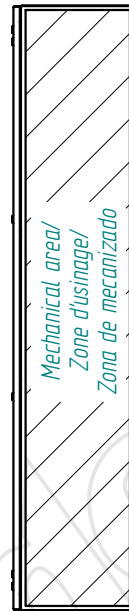

2 PLACAS



TOLERANCIA GENERAL DE MECANIZACION segun DIN 7168					Referencia:	DIBUJADO:	28/04/2015	FIRMA:	D.Martinez	
						APROBADO:	28/04/2015		D.Martinez	
	Creación del documento	28/04/2015	D.MTNEZ	A	-	DESIGNACIÓN:	tribex 2p-2000x2000x400-estandar			Nº PLANO:
MODIFICACIONES	FECHA:	FIRMA:	REVISIÓN:	plegado: acabado:						

